

# SHEEP SCALE **AVS**

## User Manual

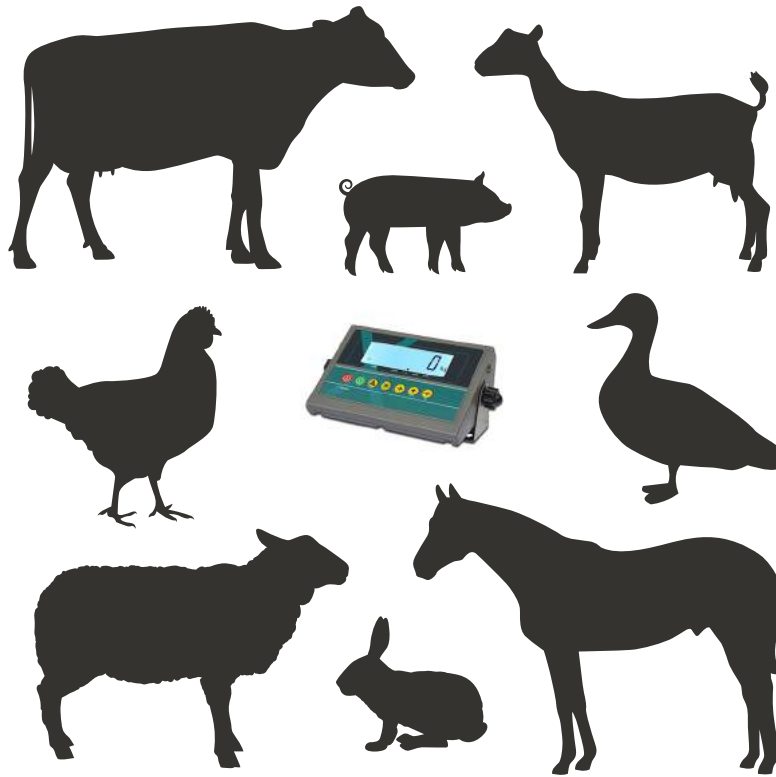

v.201811



For Livestock Weighing, please configure AUT=3 or 5!

# Before Use



## WARNING!

- ▲ Do not use X serial weighing terminals in hazardous area! Do not use it within areas classified as hazardous division 1|2 or zone 0|1|2|21|22 because of combustible or explosive atmospheres.
- ▲ Never immerse it in corrosive chemical liquid.
- ▲ Static sensitive device, it must be handled only by qualified technicians. Improper handling may damage the circuit card and the device, which is not covered by the warranty.



## DANGER!

Electric shock hazard!

- ▲ Make sure the indicator is grounded well.
- ▲ Always unplug AC cable before performing any service work on the indicator! And wait for at least 30 seconds before any operation on the indicator.



## Disposal

In conformance with the European Directive 2002|96|EC on Waste Electrical and Electronic Equipment (WEEE), this device may not be disposed of in domestic waste. This also applies to countries outside the EU as per their specific regulations.

Please dispose of this product in accordance with local regulations at the collecting point specified for electrical and electronic equipment.

If you have any questions, please contact the responsible authority or the distributor from which you purchased this indicator.

Should this indicator be passed on to other parties (for private or professional use), the content of this regulation must also be related.

The indicator has a rechargeable internal battery. The battery contains heavy metals. Please observe the local regulations on the disposal of environmentally hazardous materials.









# Index

Introduction	3
Keyboard Functions   Symbols of the Screen	3
Technical Description	4
Power On   Off	5
Configuration	5
Calibration	6
Zero   Tare   Accumulation	6
Counting	7
Clean Memory	8
How to Change the Digits	8
Battery Capacity	8
Units Exchange	8
Printing	8
Backlight Set	9
Precaution	9
X8 Supplement	10
Wireless X1FM   X3FM   X5FM Supplement	11
Bluetooth (optional)	13
Real Clock (optional)   Gravity Adjusting (optional)	14
Introducción	15
Funciones de Teclados   Símbolos de la Pantalla	15
Descripción Técnica	16
Encendido y Apagado	17
Configuración	17
Calibración	18
Cero   Tara   Acumulación	19
Muestreo y Cuenta Piezas	20
Borrar Memoria	20
Como Establecer Información	20
Capacidad de la batería	21
Unidad de Peso	21
Conexión a Mini Impresoras	21
Programar la Retroiluminación	21
Precauciones	22
X8 Suplemento	23
X1FM   X3FM   X5FM Suplemento	24
Bluetooth (Opcional)	26
Reloj (Opcional)   Ajuste de Gravedad (Opcional)	27



## 1. INTRODUCTION





- A/D resolution: 100000
- A/D sampling speed: 40 times/second.
- Display resolution: from 1/3000 up to 1/30000
- Excitation voltage: DC 5V; up to 4 load cells 350 Ω, 8 load cells 700 Ω.
- Weight unit: Kg|Lb|UU (user unit for X\*FM model)
- Communication interface: RS232 (Optional RS-485 interface)
- Rate continuous ASCII data output: 1200| 2400| 4800| 9600 Baud.
- External power supply: 100-240V AC.
- Internal rechargeable battery: 6V DC.
- Operating temperature: -10°C-40°C (LED)| 0°C-40°C (LCD)
- Storage temperature: -25°C-55°C.
- Relative humidity: ≤ 85 % non-condensing.
- Selectable display resolutions: 1|2|5|0.1|0.2|0.5|0.01|0.02|0.05|0.001|0.002|0.005|10|20|50|100|200|500|0.10|0.20|0.50|0.010|0.020|0.050
- 6-bit display:
  - X1| X3AR| X3R| X5R | X1FM | X5FM 0.8" red LED (20mm)
  - X3A| X3| X5| X5T| X5P 0.8" green LED (20mm)
  - X1C| X3AC| X3C| X5C| X3W 1.0" LCD (25mm)
  - X1B| X5B| X5BP 1.5" red LED (38mm)
  - X8 0.56" red LED(14mm)
- Dimensions:
  - X1| X1C | X1FM 255 mm(L) x 160mm(W) x 120 mm(H)
  - X1B 255 mm(L) x 160mm(W) x 135mm(H)
  - X3| X3(A)(C)| X3W 265 mm(L) x 220mm(W) x 100mm(T)
  - X5| X5C| X5B | X5FM 260 mm(L) x 145mm(W) x 80mm(T)
  - X8 242 mm(L) x 90mm(W) x 41mm(T)
  - X5P| X5BP 365 mm (L) x 183mm (W) x 94mm (T)
- Approximate weight: 2.0-2.45kg
- Wireless frequency (X\*FM): 430Mhz
- Wireless distance: 100|1000M
- Wireless communication rate: 9600bps

## 2. KEYBOARD FUNCTIONS

-  Power off (old version with STOP)
-  Power on.
-  Manual accumulation function
-  Function selection during normal operation and configuration
-  Move the flashing digit to the right during configuration or setting preset tare.
-  The display is temporarily set to 10 times resolution
-  Increase the flashing digit during configuration or setting preset tare
-  Zero the display, set the zero point or enter a tare value.

## 3. SYMBOLS OF THE SCREEN

-  Main power is applied to the indicator.
-  A weight has been tared, display is showing the net weight.
-  Battery capacity less than 30 %.

-  The scale is Zero.
-  The automatic accumulation function is active.
-  The weight is stable.
-  The unit of weighing is lb.
- x10 The display is temporarily set to 10 times resolution

**X1C | X3(A)C | X5C - LCD models:**

- [ANIM ] Animal Weighing
- [LO ] Setpoint lower than the first threshold
- [HI ] Setpoint higher than the second threshold
- [OK ] Setpoint higher than the first threshold and lower than the second one

**X1FM | X3FM | X5FM - Wireless models:**

- [Wireless] Wireless connected
- [UU ] User weighing unit mode

**4. TECHNICAL DESCRIPTION**

**4.1.1 Connection of the load cells to indicator. DB-9 pin plug**

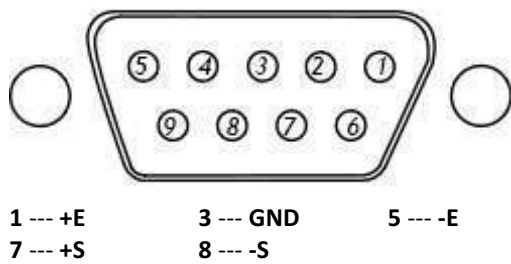

INDICATOR	LOAD CELL
+E (1)	+Excitation
-E (5)	-Excitation
+S (7)	+Signal
-S (8)	-Signal
GND (3)	(GND) shield

\* For 6 wire load cells, please short connect +E/+F, -E/-F

**4.1.2 Connection of the load cells to indicator. 5 pin plug**

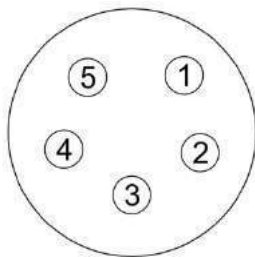

INDICATOR	LOAD CELL
+E (1)	+Excitation
-E (4)	-Excitation
+S (2)	+Signal
-S (3)	-Signal
GND (5)	(GND) shield

\* For 6 wire load cells, please short connect +E/+F, -E/-F

**4.2 RS-232 D-B 9**

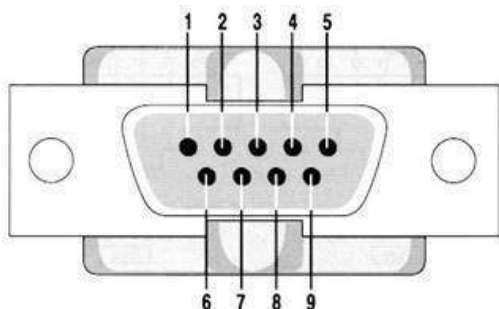

INDICATOR	COMPUTER
Pin3	Pin2
Pin5	Pin5

Pin 3: Output (TXD)

Pin 5: Signal Ground (GND)

### 4.3 Continuous ASCII RS-232 data output format

#### 4.3.1 Address: Adr=00

The ASCII data format is “=, \*1, \*2, \*3, \*4, \*5, \*6”

<stx>=, \*1, \*2, \*3, \*4, \*5, \*6”

\*1, \*2, \*3, \*4, \*5, \*6” are weight data.

If the weight is  kg, the continuous output is “=00.001=00.001=”

#### 4.3.2 Address: Adr=99

The ASCII data format is “=. \*6, \*5, \*4, \*3, \*2, \*1”

<stx>=. \*6, \*5, \*4, \*3, \*2, \*1

\*6, \*5, \*4, \*3, \*2, \*1 are weight data.

If the weight is  kg, the continuous output is “=100.00=100.00=”

#### 4.3.3 Address: Adr=1—98 manual and automatic printing output

## 5. POWER

In power off states, press  key turn on the indicator. The indicator will check the LED and display battery capacity [bPt\*\*]..

## 6. CONFIGURATION (only authorized technician can access!)

Connect load cells to the indicator and set following configuration parameters.

Step	Operation	Displaying	Contents
1	Press <input type="button" value="↵"/> and <input type="button" value="ⓘ"/> at same time	Self test from 0-9	In power off states, press <input type="button" value="↵"/> and <input type="button" value="ⓘ"/> at the same time to turn on, segment check, and displaying [UER *.*] edition No 1.5 second.
2	Press <input type="button" value="*"/>	<input type="text" value="CAL SP"/>	Enter of the scale.
	Press <input type="button" value="*"/>	<input type="text" value="-SET-"/>	Enter the configuration setting mode
3	Press <input type="button" value="→"/>	<input type="text" value="d 1"/>	The number of scale divisions selected.
	Press <input type="button" value="↑"/>	<input type="text" value="d 2"/>	0.001-0.002-0.005-10-20-50-100-200-500-0.10-0.20-0.50-0.010-0.020-0.050-1-2-5-0.1-0.2-0.5-0.01-0.02-0.05
4	Press <input type="button" value="↑"/>	<input type="text" value="d 0.1"/>	For example: d = 0.1
	Press <input type="button" value="*"/>	<input type="text" value="6000"/>	Sets scale F·S
	Press <input type="button" value="→"/>	<input type="text" value="000000"/>	Moves the digit at right.
	Press <input type="button" value="↑"/>	<input type="text" value="001000"/>	
	Press <input type="button" value="↑"/>	<input type="text" value="002000"/>	For example: F·S=3000
5	Press <input type="button" value="↑"/>	<input type="text" value="003000"/>	
	Press <input type="button" value="*"/>	<input type="text" value="FLt 10"/>	Sets display Filter parameters: 00-99
	Press <input type="button" value="→"/>	<input type="text" value="FLt 00"/>	The display will update faster and filter faster as the filter parameter is changed from 99-00.
	Press <input type="button" value="↑"/>	<input type="text" value="FLt 10"/>	
	Press <input type="button" value="↑"/>	<input type="text" value="FLt 20"/>	For example: FLt=30
6	Press <input type="button" value="↑"/>	<input type="text" value="FLt 30"/>	
	Press <input type="button" value="*"/>	<input type="text" value="AUtP00"/>	Sets automatic power off function.
	Press <input type="button" value="→"/>	<input type="text" value="AUtP00"/>	AUtP=00 Not automatic power off.
	Press <input type="button" value="→"/>	<input type="text" value="AUtP00"/>	AUtP=01 Automatic power off.
6	Press <input type="button" value="→"/>	<input type="text" value="AUtP10"/>	Digit express the choice of zero trace range (1-9): 1:0.4d 2:0.8d 3:1.2d 4:1.6d 5:2d 6:2.4d 7:2.8d 8:3.2d 9:3.6d.
	Press <input type="button" value="↑"/>		Decimal digit express the choice of zero set. Decimal digit=0 no zero set at start operation. Decimal digit >1 zero set at start operation 20% F·S.

			For example: AUtP=10 (AUtP=10 when leaving the factory)
7	Press *	Adr 00	Continuous output: Adr=00
8	Press * Press ↑	b 2400 b 4800	Baut rate range: 1200 → 2400 → 4800 → 9600 For example: b=4800
9 (LCD)	Press *	1000	No.1 setpoint output, weight<1000, display LO *
10 (LCD)	Press *	2000	No.2 Setpoint output, 1000<weight<2000, it displays OK, weight >2000, shows HI *
9	Press *	0	Press to confirm configurations and go to calibration menu.

**Note:** one time accumulation is allowed for weighing once. Following accumulation is allowed for weighing only when displayed value is below 20 d.

\*LCD display with Hi-Ok-Lo function

## 7. CALIBRATION (only authorized technician can access!)

Calibration should be done after setting the parameters

Step	Operation	Displaying	Comments
1	Press * Press →	CAL SP CAL 00	Enters calibration. Zero the scale.
2	Press *	----- 3000	Starts zero calibration and wait for zero calibration to complete.
3	Load the standard weight for F-S on the platform, press * *	----- 3000	Starts calibration and wait for calibration to complete.*

**! Calibration must be done once the parameters are configured!**

**A/D check:** Pressed \* three times during calibration or configuration, the indicator will display -A-d. To view the A/D counts, press the → key when -A-d- is displayed. Press the \* key to return to weighing mode.

\* If the standard weights can't reach to F.S., 2|3 is recommended to use, press → and ↑ to change the numbers displayed (to be the weight value of the weight you use) and then press \* to confirm.

**Example:** If only 2000Kg weights for calibration of the 3000Kg scale, after zero calibration, put 2000Kg weights on the platform and press → and ↑ to change the number to be 2000 and then press \*.

## 8. ZERO

When the weight is stable, press →0< key for two seconds to set the zero point and zero the display. The →0< status LED is turned on.

## 9. TARE

### 9.1 Digital tare.

Press → key, set tare with → and ↑ key, then press →0< key. The input data is tare. The status LED →T< is turned on.

### 9.2 Acquire tare

When Tare status LED is off and the weight is stable, press the →0< key to acquire tare and switch to net mode. The Tare status LED is turned on.

### 9.3 Remove tare



When Tare status LED is on, press →0< key will switch to gross mode and removed tare. The Tare status LED is off.

## 10. MANUAL WEIGHT ACCUMULATION

When weight is stable, press ≡ key to accumulation the current weight to the total weight. The total number of accumulation will be displayed for n 12 1.5 seconds.













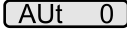



## 11. HIGH RESOLUTION DISPLAY MODE

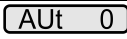

In this display mode, press , switch to high resolution display mode. (10 times normal display) The last decimal point is light on. Press  key return to normal weight display mode.

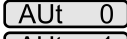
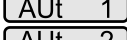
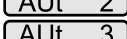
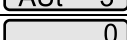
## 12. AUTOMATIC MEMORY ACCUMULATION



Selection of manual|automatic accumulation function (Selection of manual| automatic print function). Selection of animal scale, peak value retain and counting function.



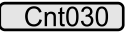



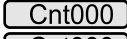
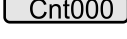

Step	Operation	Displaying	Contents
1	Press 		To display times of accumulation.
2	Press 		The selection of manual automatic accumulation AUt = 0, manual accumulation AUt = 1, automatic accumulation and print when weight is added,  indicator is lit. AUt=2, automatic memorize displayed value when weight is added. Accumulate and print final stable values after load down to below 20 d.  indicator is lit. AUt=3,dynamic weighing method. At weighing >20d: the buzzer sounds "du" and lock is displayed for 6 seconds. Then lock is released for weighing <20d; automatic accumulation and print. Suggest Flt>30.  indicator is list. AUt=4, peak value fixed weighing method. At weighing>20d, the buzzer sounds "du" and lock is displayed. When weighing <20d, fixed data displays with flash, automatic accumulation and print. Lock can be released by pressing any key.  indicator is lit. AUt=5,dynamic weighing method. Manual accumulation and print. AUt=6, peak value fixed weighing method. Manual accumulation and print. AUt=7, counting function. *note
3	Press 		Digits displays with flash.
4	Press  Press  Press 	   	Move flashing digit to the right bit. e.g. AUt=3 expresses dynamic weighing method.
5	Press 		Return to normal weighing status.

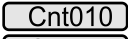
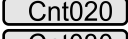
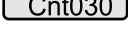

## 13. SAMPLING AND COUNTING

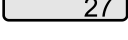

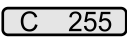

**13.1 Sampling:** when net weight on scale is zero (tare can be removed by pressing tare key if net weight is not zero), the sample, which must be <200 pieces, i.e. between 1 to 199, is put on the scale. Press  and , input quantity of the sample (e.g.30),  is displayed.

Press , confirm the completion of sampling. Weighing status is redisplayed. Sampling is memorized even with power off.



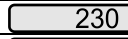

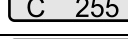

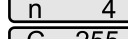
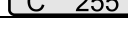

Step	Operation	Display	Description
1	Place sample		Place selected sample, weight: 27, quantity: 30.
2	Press  Press 	 	Ready to input sample's quantity. Decimal digit display with flash.

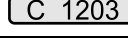
3	Press  Press  Press 	  	
4	Press 		Display sample's weight: 27,  is a confirmation key, sample collection completed.
5	Press 		Display sample's quantity,  is change-over key between weight and quantity display.

**13.2 Counting operation:** place the object on scale, weight is displayed, press ,  is displayed, and the display changes over to the quantity of the object. When the display is stable, press , accumulate the weight and quantity. Counting accumulation operation can be done during counting (after pressing )

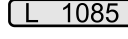

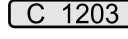
Step	Operation	Display	Description
1	Place object		Object weight: 230
2	Press 		Object quantity: 255
3	Press 	 	Display after 1.5 seconds at counting status.

### 13.3 Counting checking

Step	Operation	Display	Description
1	Press 		Display the total quantity of the object: 1203
2	Press 		Display accumulated weight 4 digits higher.
3	Press 		Display accumulated weight 4 digits lower = 1085
4	Press 		Back to counting status.
5	Press 		Delete accumulated quantity.

**Note:** Accumulation inquires and delete: both on weighing mode.

## 14. CLEAR MEMORY

Press  key. If memory has previously been cleared the display will show  followed by zero weight when the  key is pressed.

## 15. HOW TO CHANGE THE DIGITS

Press  key move and blinks the current digit to right digit

Press  key increment the current digit to the next available value.

## 16. BATTERY CAPACITY

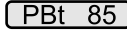
- When the indicator is being power on/off, battery capacity will be displayed  for 1.5 seconds.
- When the battery capacity is less than 20%, the display will start to blink, power off the indicator to avoid over discharging battery or connect the external main power supply.
- When the battery capacity  $\leq$  10%, the indicator automatic turn off to avoid battery over discharge
- In auto power off mode, If weight is stable and no key operation for more than >3 minutes, The indicator displays [- ] to conserve battery
- When auto power off setting is action, If weight is stable and no key operation > 30 minutes automatic turn off power
- A full charged battery life is approximately 30 hours.

## 17. UNIT OF WEIGHING (kg and lb)

kg or lb is selectable. The unit of weighing is kg normally. You can change it to lb by pressing and holding  key 2 seconds at least.

## 18. CONNECTION TO MINI-PRINTERS

Connect serial interface printer with the following way:

Indicator		Mini Printer
3	----TXT----	2
5	----GND----	7

**Note:** Before connection to printer, communication address is set as Adr=01; baud rate is set as b=2400.

Print operation with serial port printer is as follows:

**18.1 Print:** at weighing status, weighing data >20d and display is stable, press , weighing sheet is printed out. The second printing can be operated only when the weighing data is back to <20d.

**18.2 Accumulated print:** at weighing status, press , then press , accumulated printing can be operated.

**18.3 Auto Print:** set to be automatic accumulation status, i.e. automatic print.

On weighing mode: weighing data >20d and display is stable, weighing sheet is printed out. The second printing can be operated only when the weighing data is back to <20d and more weight is loaded.

Following with print sample:

Normal printing	Accumulation printing
No:1 (serial number)	No:9 (serial number)
Gross: 3940 kg (gross weight)	W: 8225 kg (accumulated weight)
Tare: 2000 kg (tare weight)	
Net: 1940 kg (net weight)	

## 19. BACKLIGHT SET (LCD model)

**On:** On weighing mode, press  for 2 seconds, the backlight will be on, press any button or while the weight value changing, the backlight will last for 15 seconds, and when the weight value back to zero, it will off automatically after 5 seconds.

**Off:** Press  for 2 seconds to off the backlight.







## 20. PRECAUTION

- Indicator should be far away from heat resource while using.
- Do not place the indicator in the dusty surroundings or the site vibrant.
- Cannot use full capacity. Over load stops hitting platform support is not permitted.
- To ensure to keep out of chemical erosion, Operating temperature range will be -10...40°C (LCD with 0...40°C), relative humidity is no less than 85%, without any corrupt gas in air.
- Never pour the water into the indicator.
- Housing, head pallet, wire connector should be sealed entirely. Users do not open sealed device or connect with wire without any expert advice. In case any malfunction of indicator occurs, please sent the indicator for maintenance.
- The indicator will charge the internal battery at all times when it is connected to the main power.



## 1. INTRODUCCIÓN







- A/D resolución: 100.000
- A/D velocidad de muestreo: 40 veces/segundo.
- Alimentación: 5 V dc; hasta 4 células de carga 350 Ω ,  
8 células de carga 700 Ω .
- Unidades Kg|Lb
- Interfaz: RS-232 de serie. Interfaz RS-485 opcional.
- Velocidad de transmisión de datos: 1200| 2400| 4800| 9600 baudios.
- Alimentador externo: 100V – 240V AC.
- Batería interna recargable: 6V DC.
- Temperatura de funcionamiento: -10°C-40°C (LED)| 0°C-40°C (LCD).
- Temperatura de almacenamiento: -25°C - 55°C.
- Humedad relativa: ≤ 85 % sin condensación.
- Resolución de pantalla seleccionable: 1|2|5|0.1|0.2|0.5|0.01|0.02|0.05|0.001|0.002|0.005|10  
|20|50|100|200|500|0.10|0.20|0.50|0.010|0.020|0.050
- 6-bit pantalla:
  - X1| X1FM| X3AR| X3R| X5R 0.8" LED rojo (20mm)
  - X3A| X3| X5| X5FM| X5T| X5P 0.8" LED verde (20mm)
  - X1C| X3C| X5C| X3W 1.0" LCD (25mm)
  - X1B| X5B| X5BP 1.5" LED rojo (38mm)
  - X8 0.56" LED rojo (14mm)
- Dimensiones:
  - X1| X1C| X1FM 255 mm(L) x 160mm(W) x 120 mm(H)
  - X1-B 255 mm(L) x 160mm(W) x 135mm(H)
  - X3| X3(A)(C)| X3W 265 mm(L) x 220mm(W) x 100mm(T)
  - X5| X5C| X5B|X5FM 260 mm(L) x 145mm(W) x 80mm(T)
  - X8 242 mm(L) x 90mm(W) x 41mm(T)
  - X5P| X5BP 365 mm (L) x 183mm (W) x 94mm (T)
- Peso aproximado: 2.0-2.45kg
- Frecuencia inalámbrica (X\*FM) 430MHz
- Distancia inalámbrica 100|1000M
- Comunicación inalámbrica tipo 9600Bps

## 2. FUNCIONES DE TECLADO

-  Parada rápida.
-  Encender o apagar el indicador.
-  Función de selección durante operación normal y configuración.
-  Función manual de acumulación.
-  Mueve el dígito encendido hacia la derecha durante la configuración o el previo establecimiento de tara.
-  Incrementa el dígito encendido durante la configuración o el previo establecimiento de tara.
-  Pantalla de cero y establecer punto de cero o entrar un valor de tara.

## 3. SÍMBOLOS DE LA PANTALLA

-  Se aplica la potencia principal al indicador.
-  Se ha tarado un peso y la pantalla muestra su peso neto.

-  Capacidad de la batería inferior a 30 %.
-  Pantalla de cero.
-  La función automática de adición de peso está activada.
-  Peso estable.
- lb  La unidad de pesada es lb.
- x10  El aumento de resolución a ser 10 veces temporalmente

**X1C|X3(A)C|X5C-LCD modelos**

- [ANIM ] Pesaje de animales
- [LO ] El peso es menor que el límite mínimo
- [HI ] El peso es mayor que el límite máximo
- [OK ] El peso esté entre el límite máximo y el mínimo

**X1FM|X3FM|X5FM-Wireless modelos:**

- [Wireless] inalámbrica conectado
- [UU ] Unidad del usuario

**4. DESCRIPCIÓN TÉCNICA**

**4.1.1 Conexión de las células de carga al indicador por la clavija de DB-9**

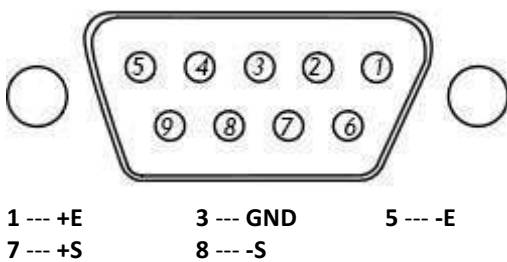

INDICADOR	CÉLULAS
+E (1)	+Excitacion
-E (5)	-Excitacion
+S (7)	+Señal
-S (8)	-Señal
GND (3)	(GND) Protección

**4.1.2 Conexión de las células de carga al indicador por la clavija de 5 pins**

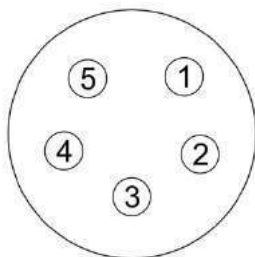

INDICADOR	CÉLULAS
+E (1)	+ Excitacion
-E (4)	- Excitacion
+S (2)	+ Señal
-S (3)	- Señal
GND (5)	(GND) Protección

**4.2 RS-232 D-B 9**

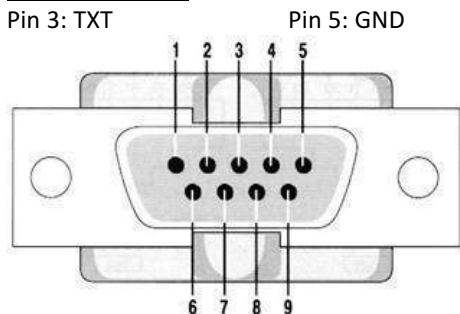

INDICATOR	ORDENADOR
Pin3	Pin2
Pin5	Pin5

### 4.3 Formato de salida continua de datos ASCII RS-232

#### 4.3.1 Dirección de mensaje: Adr=99

El formato de la información ASCII es “=. \*1, \*2, \*3, \*4, \*5, \*6”

<stx>=, \*1, \*2, \*3, \*4, \*5, \*6

\*1, \*2, \*3, \*4, \*5, \*6 son datos de peso.

#### 4.3.2 Dirección de mensaje: Adr=00

El formato de la información ASCII es “=. \*6, \*5, \*4, \*3, \*2, \*1”

<stx>=, \*6, \*5, \*4, \*3, \*2, \*1

\*6, \*5, \*4, \*3, \*2, \*1 son datos de peso.

Si el peso es  kg, la salida de datos continua es “=100.00”

#### 4.3.3 Dirección de mensaje: Adr=1—98 salida impresora serie

## 5. ENCENDIDO Y APAGADO













Cuando está apagada presione la tecla  para encender el indicador. El indicador comprobará el LED y la capacidad de batería en la pantalla  durante 1,5 segundos.

Cuando está encendido, presione la tecla  durante 2 segundos y mostrará la capacidad de la batería  durante 1,5 segundos y después el indicador se apagará.

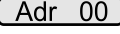
## 6. CONFIGURACIÓN (¡solo un técnico autorizado puede acceder!)

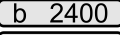
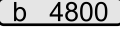
Conecte las células de carga al indicador y establezca los siguientes parámetros de configuración.









Paso	Operación	Pantalla	Contenidos
1	Presionar <input type="button" value="→0←"/> y <input type="button" value="Ⓚ"/> simultáneamente	Autotest de <input type="text" value="0"/> , hata <input type="text" value="9"/> <input type="text" value="0"/>	Cuando está apagado, presione <input type="button" value="→0←"/> y <input type="button" value="Ⓚ"/> simultáneamente para encenderlo, comprobación de segmentos y pantalla. Esperar a que se realice todo el test. [UER *.*] edición nº 1.5 segunda.
2	Presione <input type="button" value="*"/> Presione <input type="button" value="*"/> Presione <input type="button" value="→"/>	<input type="text" value="CAL SP"/> <input type="text" value="-SET-"/> <input type="text" value="d 1"/>	Entrar la balanza. Entrar al modo de establecer la configuración. Ha sido seleccionado el número de divisiones de la balanza.
3	Presione <input type="button" value="↑"/> Presione <input type="button" value="↑"/>	<input type="text" value="d 2"/> <input type="text" value="d 0.1"/>	1   2   5   0.1   0.2   0.5   0.01   0.02   0.05   0.001   0.002   0.005   ... Por ejemplo: d=0.1
4	Presione <input type="button" value="*"/> Presione <input type="button" value="→"/> Presione <input type="button" value="↑"/> Presione <input type="button" value="↑"/> Presione <input type="button" value="↑"/>	<input type="text" value="6000"/> <input type="text" value="000000"/> <input type="text" value="001000"/> <input type="text" value="002000"/> <input type="text" value="003000"/>	Establece F·S Mover el dígito al bit de la derecha.  Por ejemplo: F·S=3000
5	Presione <input type="button" value="*"/> Presione <input type="button" value="→"/> Presione <input type="button" value="↑"/> Presione <input type="button" value="↑"/> Presione <input type="button" value="↑"/>	<input type="text" value="FLt 10"/> <input type="text" value="FLt 00"/> <input type="text" value="FLt 10"/> <input type="text" value="FLt 20"/> <input type="text" value="FLt 30"/>	Establece el dígito de los parámetros de filtro: 00-99 La pantalla se actualizará y filtrará más rápido ya que el parámetro de filtro ha cambiado de 99-00.  Por ejemplo: FLt=30
6	Presione <input type="button" value="*"/>	<input type="text" value="AUtP00"/> <input type="text" value="AUtP00"/>	Establece la función de apagado automático. AUtP=00 Desconectar apagado automático.

	Presione  Presione  Presione 	 	AUtP=01 Conectar cierre automático. dígito expreso para escoger la búsqueda de rango cero (0-9): 1:0.4d 2:0.8d 3:1.2d 4:1.6d 5:2d 6:2.4d 7:2.8d 8:3.2d 9:3.6d. El dígito decimal expresa la elección de fijación de 0. Dígito decimal=0 no se establece cero al empezar la operación. Dígito decimal>1 establece cero al empezar la operación 20% F.S. Por ejemplo: AUtP=10 (AUtP=10 cuando deja la fábrica)
7	Presione 		Salida continuada: Adr=00
8	Presione  Presione 	 	Ratio de baudios: 1200 → 2400 → 4800 → 9600 Por ejemplo: b=4800
9 (LCD)	Presione 	1000	El peso límite mínimo, si el peso <1000, display LO*
10 (LCD)	Presione 	2000	EL peso límite máximo, si el peso esté entre 1000 y 2000, displays OK, si el peso >2000, display HI *
11	Presione 		Presionar para confirmar configuraciones e ir al menú de calibraciones.

\* Nota: cada pesada permite un tiempo de acumulación. Acumulación seguida se permite cuando el valor mostrado es inferior a 20 d.



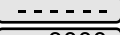
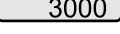

\* *Hi-Ok-Lo función de los modelos de LCD pantalla*

## 7. CALIBRACIÓN (¡solo un técnico autorizado puede acceder!)

Paso	Operación	Pantalla	Contenidos
1	Presione  Presione 	 	Entrar calibración. Balanza a cero.
2	Presione 	 	Empezar calibración cero y esperar que la calibración termine.
3	Cargue el peso estándar para F-S sobre la plataforma, presione 	 	Empezar calibración cero y esperar que la calibración termine.

Notas:



1. La calibración debe efectuarse una vez configurados los parámetros.

2. Una vez presionada la tecla  tres veces durante la calibración o configuración el indicador aparecerá. Para ver las cuentas A|D, presione la tecla  cuando se muestre . Presione la tecla  para volver al modo anterior.

3.1 Si las pesas de calibración no puede llegar a F.S. (la capacidad), 2|3 pesas de calibración o más se recomienda, por ejemplo, para 3000Kg bascula, es mejor usar 3000kg pesos o 2000kg (es más de 2|3 de la capacidad) si no hay 3000 kg de pesas





3.2 Poner el 2000Kg pesas en la plataforma, y presione  y  a cambio el numero a 2000 y luego presione 

## 8. CERO



Cuando el peso está estable, presione la tecla  durante 2 segundos para establecer el punto cero y la pantalla a cero, el LED de estado  se enciende.

## 9. TARA



### 9.1 Tara digital

Presione la tecla , establezca tara con  y tecla , después presione la tecla . La información de entrada es tara. El LED de estado  se enciende.

## 10. ADICIÓN DE PESO MANUAL









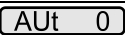

Cuando el peso esté estable, presione la tecla  para añadir el peso actual al peso total. El número total de adiciones será mostrado al cabo de  1.5 segundos.

## 11 AUMENTO DE LA RESOLUCIÓN

Presione  a aumentar la resolución por 10 veces, presione  de nuevo a volver a el modo normal.

## 12. ACUMULACIÓN DE MEMORIA AUTOMÁTICA

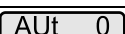
Selección de la función de acumulación manual| automática (selección de la función de impresión manual o automática). Selección de la balanza animal, retención de valor máximo y función cuenta piezas.

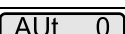
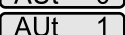
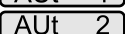
Paso	Operación	Pantalla	Contenidos
1	Presione 		Para mostrar las veces de acumulación.
2	Presione 		<p>La selección de acumulación manual  automática            AUt = 0, acumulación manual            AUt = 1, acumulación e impresión automática cuando se añade el peso, el indicador  se enciende.            AUt=2, se muestra el valor de memoria automática cuando un peso es añadido.            Valores estables de acumulación e impresión después de una carga inferior a 20d. El indicador  se enciende.</p> <p>AUt=3, método dinámico de peso. Con un peso &gt;20d: la alarma suena "du" y se muestra la carga durante 5 segundos. Cuando se añade una nueva información está vuelve a mostrarse durante 6 segundos y se cierra .            Entonces el cierre desaparece para peso &lt;20d; acumulación automática e impresión . Se sugiere FLT&gt;30.            El indicador  se enciende.</p> <p>AUt=4, método de peso con valor máximo fijo. Si el peso es &gt;20d, la alarma suena "du" y se cierra. El indicador  se enciende.            Cuando el peso &lt;20d, la información fija aparece con flash, acumulación automática e impresión. Se puede quitar el cierre presionando cualquier tecla. El indicador  se enciende.            AUt=5, método de pesado dinámico. Acumulación e impresión manual.            AUt=6, método de pesado con valor máximo fijo. Acumulación e impresión manual            AUt=7, función cuenta. *nota</p>
3	Presione 		Se muestran los dígitos con flash.
4	Presione  Presione 	  	Establece F-S Mover el dígito hacia el bit derecho e.g. AUt=3 señala el método de pesado dinámico.



	Presione	AUt 3	
5	Presione	0	Vuelve al estado de pesado normal.

### 13. MUESTREO Y CUENTA PIEZAS

\* nota (1) muestra: Cuando el peso neto sobre la balanza es cero (se puede quitar la tara con la tecla tara si el peso neto no es cero), la muestra, la cual debe ser <200 piezas, i.e. entre 1 a 199, se coloca encima de la balanza. Presionar y , la pantalla mostrará la cantidad de entrada de la muestra (ej.30),

Presionar , confirmar la finalización de la muestra. La función peso vuelve a mostrarse. La muestra es memorizada incluso cuando la balanza está apagada.

Paso	Operación	Pantalla	Contenidos
1	Sitúe la muestra		Sitúe muestra seleccionada, peso:27, cantidad 30.
2	Presione Presione	 	Preparada para introducir la cantidad de muestra. Dígito decimal se muestra con flash.
3	Presione Presione Presione	  	
4	Presione		La pantalla de peso enseña 27,  es una tecla de confirmación de muestra completada.
5	Presione		Mostrar cantidad muestra,  es una tecla de cambio entre peso y cantidad mostrada.

(2) Operación de cuenta piezas:sitúe el objeto sobre la balanza, cuando se muestre el peso, presione , la pantalla muestra , y la pantalla cambia según la cantidad del objeto. Cuando la pantalla esté estable, presione , acumula el peso y la cantidad. La acumulación puede realizarse sólo en posición de contar.

Paso	Operación	Pantalla	Contenidos
1	Sitúe un objeto		Peso objeto: 230
2	Presione		Cantidad objeto: 255
3	Presione	 	La pantalla muestra después de 1,5 segundos en posición de cuenta.

Paso	Operación	Pantalla	Contenidos
1	Presione		Mostrar la cantidad total de objeto: 1203
2	Presione		Peso acumulado mostrado 4 dígitos más alto.
3	Presione		Peso acumulado mostrado 4 dígitos más bajo = 1085
4	Presione		Vuelve a la función cuentapiezas.
5	Presione		Borrar cantidad acumulada.

(3) cuestiones de acumulación y borrado: ambas en estado de pesar y posición de cuenta.

### 14. BORRAR MEMORIA

Presionar la tecla . Si la memoria no ha sido borrada previamente la pantalla mostrará seguida por un peso cero cuando se presiona la tecla .

## 15. COMO ESTABLECER INFORMACIÓN

Presionar la tecla  para mover y mostrar el dígito actual.

Presionar la tecla  para incrementar el dígito actual hacia el valor próximo a mano.

## 16. CAPACIDAD DE LA BATERÍA

- Cuando se enciende o se apaga el indicador, se mostrará la capacidad de la batería **PBt 85** durante 1,5 segundos.
- Cuando la capacidad de la batería es inferior al 20%, la pantalla empezará a titubear, apague el indicador para evitar que la batería se descargue demasiado o conéctela al suministrador externo de potencia principal.
- La batería completamente cargada dura aproximadamente 30 horas.

## 17. UNIDADES DE PESO (kg y lb)

Se puede seleccionar kg o lb. La unidad de peso normal es kg. Usted puede cambiarla a lb presionando y aguantando durante 2 segundos como mínimo la tecla .

## 18. CONEXIÓN A MINI IMPRESORAS

Conecte el puerto de impresoras de serie clase UP-16TS como se indica a continuación:

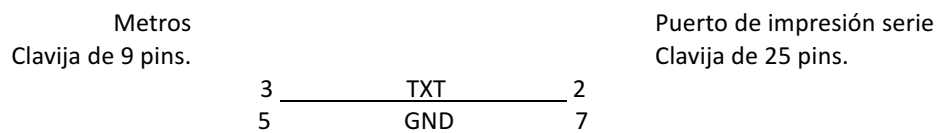

*\* Nota: Antes de conectar a la impresora, la dirección de comunicación se establece como ADR=1; el ratio de baudios se establece a b=9600.*

Operación de impresión con puerto de impresión de serie es tal como se especifica:

17.1 Impresión: en función del peso, información de peso >20d y la pantalla se encuentra estable, presione , se imprime la hoja de peso. La segunda impresión puede realizarse solo cuando la información de peso vuelve a <20d.

17.2 Impresión de acumulación: en función de peso, presione , y después presione , la impresión de acumulación ya puede funcionar.

17.3 Establecer la función de acumulación automática, i.e. impresión automática.

En función de peso, la información de peso >20d y la pantalla esté estable, aparece la hoja de impresión. La segunda impresión puede realizarse solo cuando la información de peso vuelve a <20d y se carga más peso.

Adjuntamos muestra de impresión:

Impresión normal	Impresión de acumulación
No:1 (número de serie)	No:9 (número de serie)
Gross: 3940 kg (peso bruto)	W: 8225 kg (peso acumulado)
Tare: 2000 kg (peso tara)	
Net: 1940 kg (peso neto)	

## 19. PROGRAMAR LA RETROILUMINACIÓN (LCD modelos)

**On:** Pludr  durante 2 segundos, la retroiluminación se encenderá, y la estancia de 15 segundos cuando presione cualquier tecla o añada carga en la balanza. La retroiluminación se apagará cuando no operación de 5 segundos (cero de la pantalla).

**Off:** Pulse  durante 2 segundos a apagar la retroiluminación.

## **20. PRECAUCIONES**

- El indicador en uso debe encontrarse lejos de una fuente de calor.
- No sitúe el indicador en sitios con polvo o vibrantes.
- No puede utilizar capacidad plena . La sobre carga no está permitida.
- Asegúrese de mantenerlo alejado de cualquier erosión química.
- El rango de temperatura de funcionamiento será  $-10-40^{\circ}\text{C}$  ( $0-40^{\circ}\text{C}$  de los modelos LCD), la humedad relativa no es inferior a 85%, sin ningún gas corruptor en el aire
- No volcar nunca agua sobre el indicador.
- Cubierta, paleta protectora , y enchufe conector deben ser sellados completamente . Los usuarios no deben abrir los objetos sellados o conectar al cable sin consejo de un experto. En caso de que ocurra cualquier funcionamiento erróneo del indicador, por favor envíe el indicador a mantenimiento.
- El indicador cargará la batería interna siempre que esté conectado a la potencia principal.

AVS

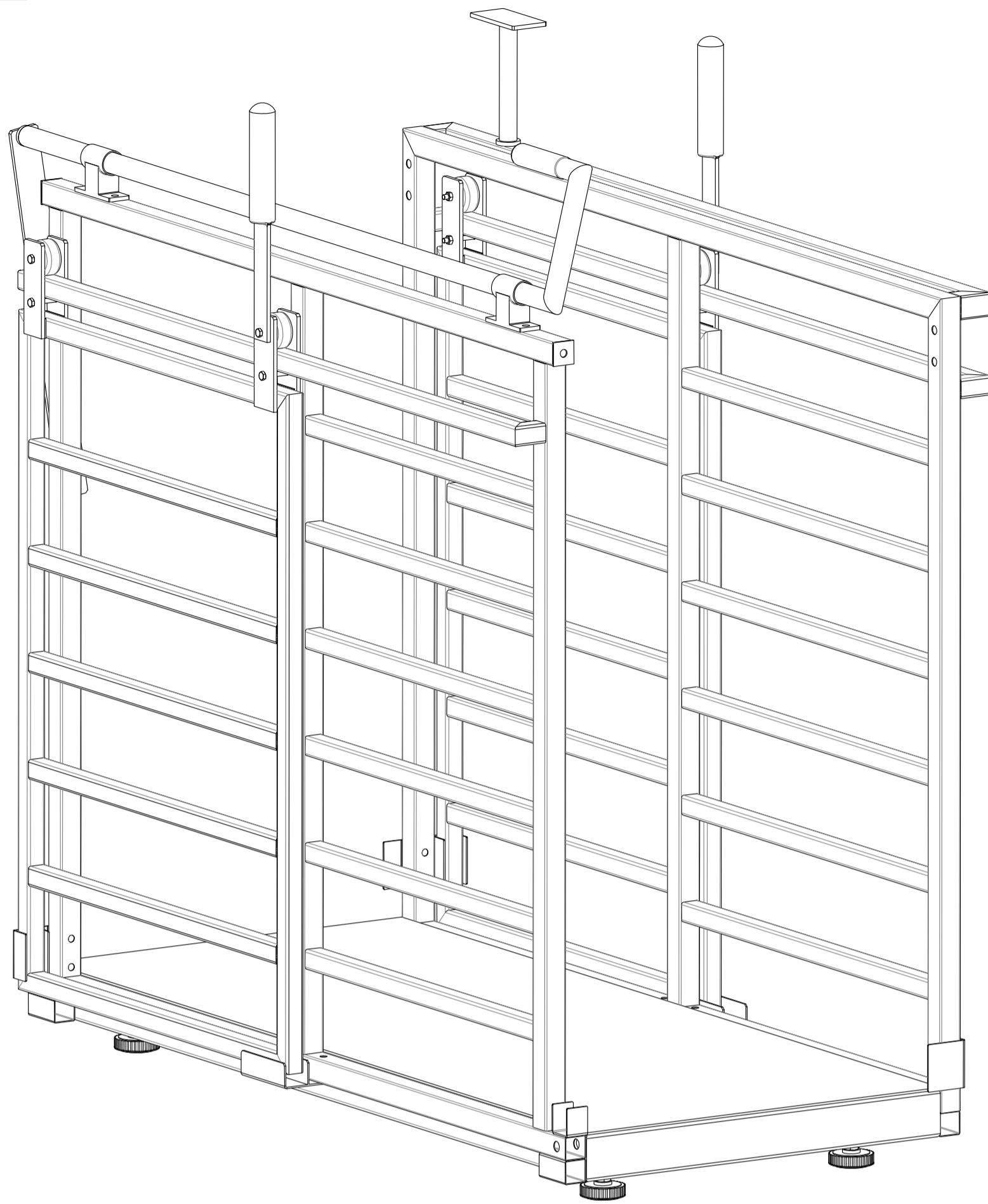

Installation

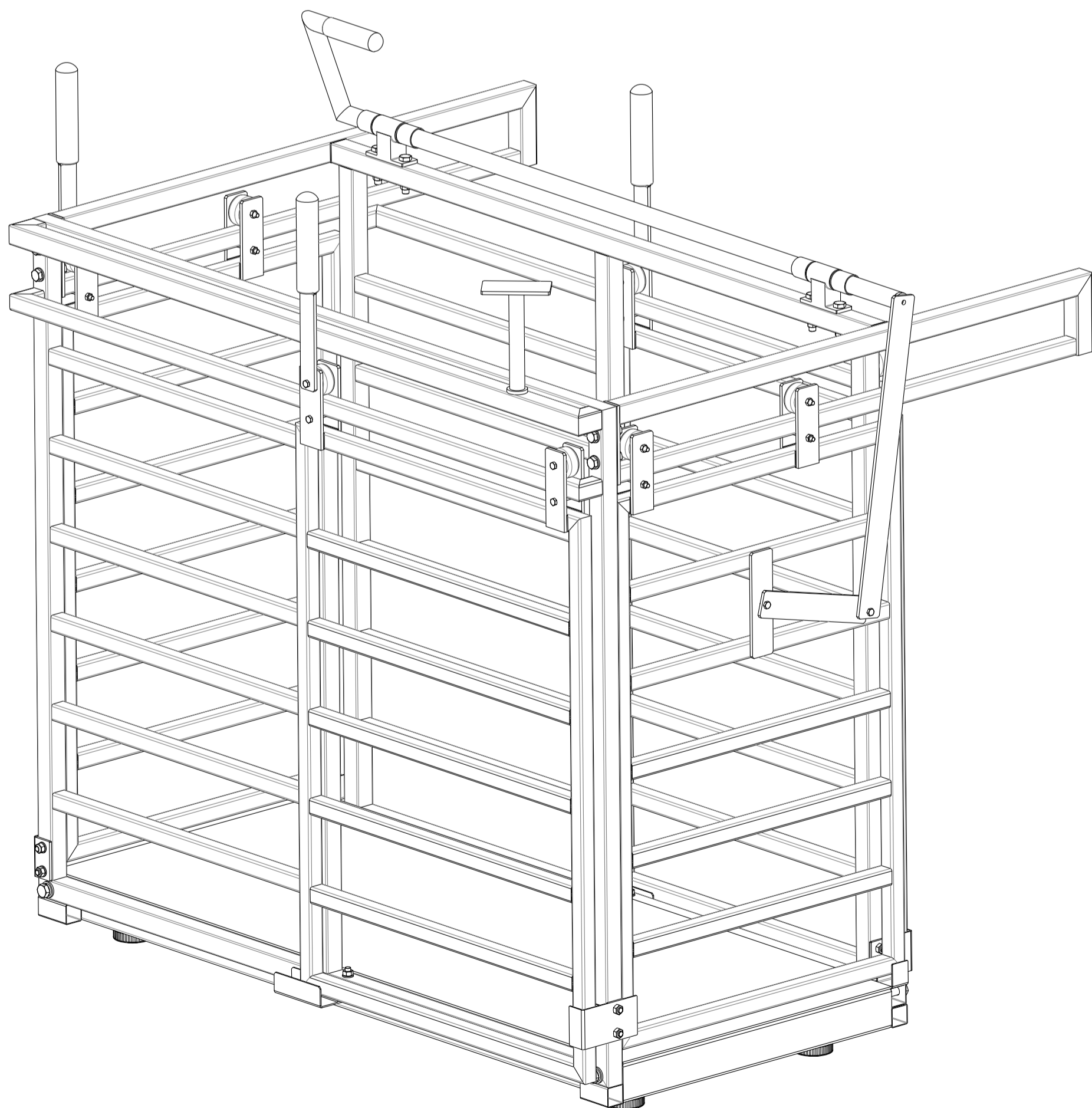

Finish





v.201811  
User Manual  
**AVS**