



WEIGHING INDICATOR K9

User Manual

VALUE EACH GRAM
HiWEIGH

Before Use

1.1 Safety precautions



WARNING!

▲ Do not use K8 K9 series weighing terminal in hazardous area! Do not use it within areas classified as hazardous division 1/2 or zone 0/1/2/21/22 because of combustible or explosive atmospheres.



▲ Never immerse it in corrosive chemical liquid.

▲ Static sensitive device, it must be handled only by qualified technicians. Improper handling may damage the circuit card and the device, which is not covered by the warranty.



DANGER!

Electric shock hazard!

▲ Make sure the indicator is grounded well.

▲ Always unplug AC cable before performing any service work on the indicator! And wait for at least 30 seconds before any operation on the indicator.



Disposal

In conformance with the European Directive 2002/96/EC on Waste Electrical and Electronic Equipment (WEEE), this device may not be disposed of in domestic waste. This also applies to countries outside the EU as per their specific regulations.

Please dispose of this product in accordance with local regulations at the collecting point specified for electrical and electronic equipment.

If you have any questions, please contact the responsible authority or the distributor from which you purchased this indicator.

Should this indicator be passed on to other parties (for private or professional use), the content of this regulation must also be related.

The indicator has a rechargeable internal battery. The battery contains heavy metals. Please observe the local regulations on the disposal of environmentally hazardous materials.

Introduction

Thank you for selecting and purchasing our K9 weight indicator, this indicator provides a compact and flexible solution for a variety of weighing needs, especially for the wet working places.



INVENTIONS AND DESIGN PATENTED
ON17-P31351 & ON17-P20743

Double O-ring for the housing, independent sealed PCB case, transparent PC front housing and touch buttons, all give the highest protection class till IP68 and IP69K, it can be used perfectly in the field of meat, fish process or any other food industry, chemical materials, pharmaceuticals. It can be washed by the high pressure hot water - 100 bar (1450 psi) and 80°C, suitable for almost all harsh working environment.

PC alloy front housing and PBT back housing, give the indicator the high strength, no worry any more about the damage to it caused by falling, crudely use of some careless workers.

It gives three options of checkweigh function, you can select the three small LED lights for checkweigh alarming, also you can set the different backlight for different range of the weight read, or you can connect with an extra alarming light with three colors.

Various power choices:

100-240V AC Direct

9-24V DC Direct

7.4V6800mA Li-ion Battery

6V1200mA Lead-acid Battery

Various output choices:

Double RS232

4 x OUTPUT

1 x IN*

Optional Bluetooth or WiFi

** for pedal or mechanical switch, functions can be set with zero, tare or print.*

Index

Technical Specifications	4
Model Identification	4
Packing List	5
Connecting	5
Power board	5
I&O board	5
Load cell	6
RS232	6
Input & Output	6
LCD Display	7
Keypad	8
Parameter setting and calibration	9
Operating method	9
F1 – Scale parameter setting	10
F2 – User functions setting	11
F3 – Display parameters	13
F4 – COM parameters setting	14
F5 – Maintenance	16
Indications & remarks	19
Main functions	19
Communication protocols	21
SM continuous output format	21
MT continuous output format	21
AN continuous output format	23
Demand output	23
Printing format	23

1. Technical Specifications

Model	K8 K8S K9
Enclosure Type	PBT SUS304 PBT+PC
Product Dimension	240x160x110mm (K8, K9) 250x170x65mm (K8S)
Shipping Weight	2.8kg (K8, K9) 3.3Kg (K8S)
Accuracy	Class III
Display Resolution	1/3,000 – 1/30,000
Power	100-240V AC 9-24V DC 7.4V6800mA Li-ion Battery 6V1200mA Lead-acid battery
Display	FSTN LCD with mutli-color backlight
Load cell No.	6*350ohm or 12*700ohm
Excitation voltage	5 VDC
Units	Kg lb, g oz
Operating Temperature	-10°C~40°C
Storage Temperature	-25°C~55°C
Relative humidity	85%Rh non-condensing
Communication	RS232*2, Optional Bluetooth

2. Model Identification

Model: K9 -AC UK 1 0
 Corresponding: A B C D E

A = Main model name

B = Power source: -AC: AC power cord + AC/DC power PCB.
 -DC: DC power direct.
 -Li: Li-ion 7.4V6800mA battery
 -La: Lead-acid 6V1200mA battery

C = Plug type, examples:

- | |
|---|
| AU = Australia Type
CN = China Type
EU = EU Type
US = USA Type
SA = South Africa Type
UK = UK Type |
|---|

D = Output: 0 = RS232*2
 1 = Bluetooth

E = pending, no function

3. Packing List

After the weighing terminal received, please open the box carefully and check the following items included:

- Indicator x 1
- S.S bracket with screws x 1
- Connectors and screws bag x 1
- Manual x 1

4. Connecting

4.1 POWER BOARD

K8Ac, K8SAc and K9Ac with only AC/DC power PCB.

K8Dc, K8SDc and K9Dc without AC/DC and DC/DC PCB, DC power connect to I/O board.

K8Li, K8SLi and K9Li with both AC/DC and DC/DC PCB, battery connect to DC/DC board.

K8La, K8SLa and K9La with only AC/DC power PCB, battery connect to I/O board.

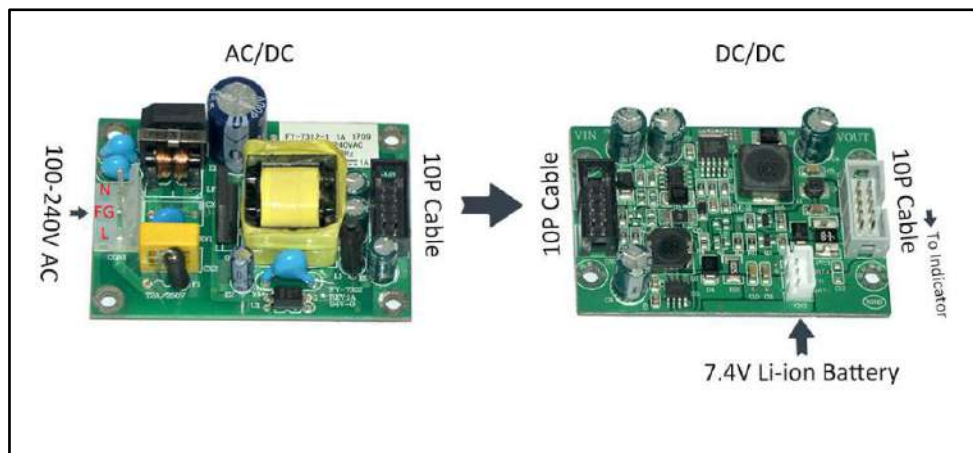

4.2 I&O BOARD

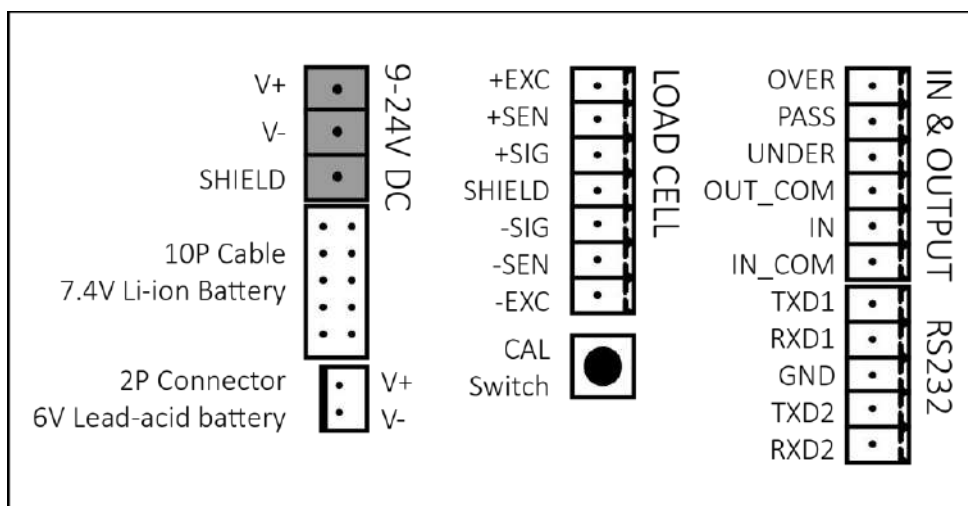

4.3 LOAD CELL

For 6-wires, just connect as the indication on the I/O board:

K8, K9 Load Cell

+EXC.....	Excitation +
+SEN.....	Sense +
+SIG.....	Signal +
SHIELD.....	Shield
-SIG	Signal –
-SEN.....	Sense –
-EXC.....	Excitation –

For 4-wires, short connect: **+EXC and +SEN, –SEN and -EXC.**

K8, K9 Load Cell

+EXC.....	Excitation +
+SEN.....	Excitation +
+SIG.....	Signal +
SHIELD.....	Shield
-SIG	Signal –
-SEN.....	Excitation –
-EXC.....	Excitation –

4.4 RS232

The terminal has two independent RS232 output, TXD1 and RXD1 for the 1st output and TXD2 and RXD2 for the 2nd output, GND share.

K8, K9 Computer/Printer, etc.

TXD.....	RXD
RXD.....	TXD
GND.....	GND

4.5 INPUT & OUTPUT

4.5.1 Diagram and wirings:

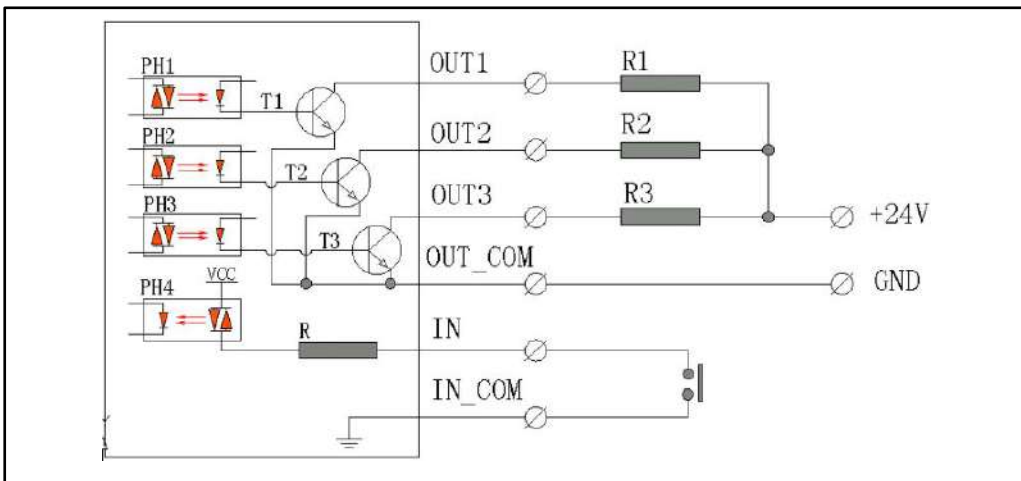

4.5.2 INPUT

The terminal has one Input interface, which allows the user to connect with foot pedal or other mechanical switch to control the functions of ZERO, TARE, PRINT, F1 or F2 (*refer to F2.3*).

Example of connecting to pedal switch

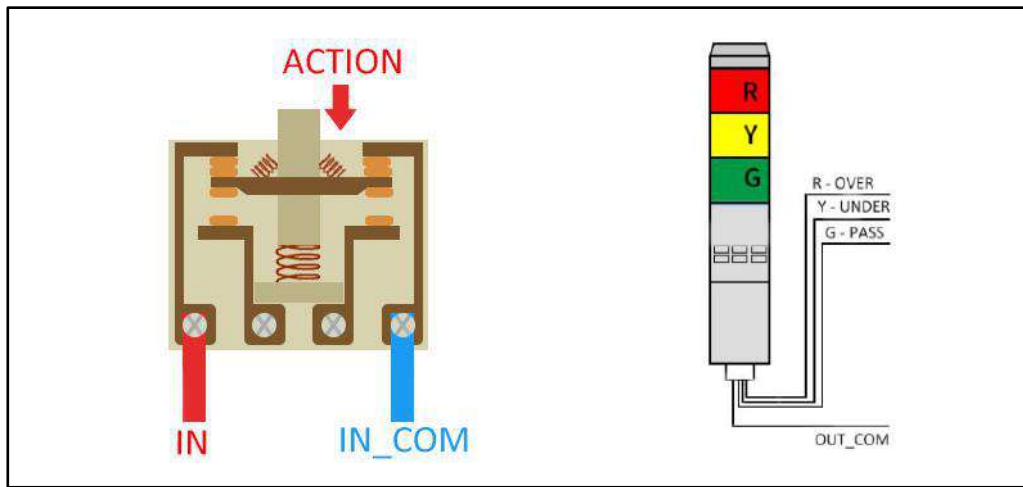

4.5.3 OUTPUT

The terminal has 3 output interface, which allows the user to connect with alarming light or other devices.

Example of connecting to 3-lights tower (charter as above)

5. LCD Display

FSTN LCD with multi-color backlight, clearly read even in the bright sunlight.

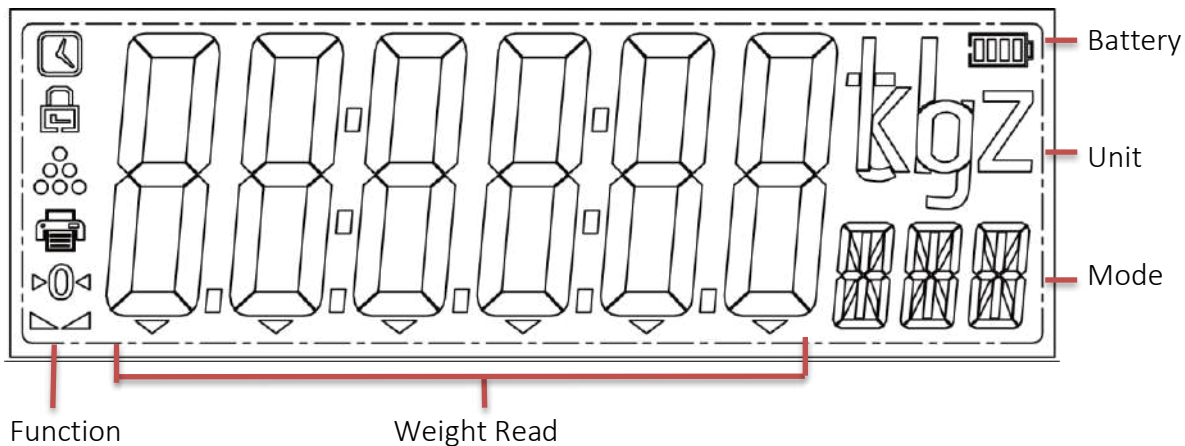

The backlight color can be set by the user, and also it allows to set different colors for checkweigh function (*refer to F2.8 & F2.9*)









6. Keypad

K8 and K8S with membrane keypad, K9 with touch keypad which allows the user to operate it in faster way, even with hand gloves, there are 6 function keys:

(keypad example of K9 model)





-  On/Off key
-  Zero key
ESC or return during parameter Setting
-  Tare key
Enter function during parameter Setting
-  F1 – User function 1
Move the digits to right during parameter Setting
-  F2 – User function 2
Increase the digits during parameter Setting
-  Printing key

7. Parameter Setting and Calibration

7.1 Operating Method

Keep pressing  key for 3 seconds, it will enter the user parameter Setting mode, only F2-F5 available.

Open the indicator, and keep pressing CAL switch (**SW1**) key on the I/O board, it can enter the full parameter Setting (F1-F5) and calibration mode, only authorized technician allows to do this Setting.

When it displays F1 (or F2), press  key to enter next step and press  key to return to previous step, press  key to change the number.

Example:

Display	Operation	Explanation
<i>F1</i>	Press TARE	Enter to F1
<i>F1.1</i>	Press TARE	Enter to F1.1
<i>F1.1.1</i>	Press TARE	Enter to F1.1.1
<i>1</i> <i>Aut</i>	Press TARE	Approval mode
<i>F1.1.1</i>	Press TARE	Confirm mode 1 and back to F1.1.1
<i>F1.1.2</i>	Press F2	Change to F1.1.2
<i>F1.1.2</i>	Press TARE	Enter to F1.1.2
<i>000006kg</i> <i>CAP</i>	Press TARE	Capacity set
<i>F1.1.2</i>	Press ZERO	Cancel Setting of CAP and back to previous step of F1.1.2
<i>F1.1</i>	Press ZERO	Back to F1.1
<i>F1.2</i>	Press F2	Change to F1.2 Setting
<i>F1</i>	Press ZERO	Cancel F1.2 Setting and back to F1
<i>0000.00kg</i>	Press ZERO	Back to normal weighing mode

During parameter data modifying, press  key to move the digit and press  key

key to change the digit, and press  key to confirm.

7.2 F1-F5 Technical Setting

F1 – Scale Parameter Setting

F1.1

F1.1.1 - **Approval mode**
1 (*default*) = Non-approval
2 = OIML mode
3 = NTEP mode

F1.1.2 - **Full Scale (Capacity)**
1 – 999999 (*default = 000006*)

F1.1.3 - **Decimal point**
0 – 4 (*default = 3*)

F1.1.4 - **Division**
1, 2, 5, 10, 20, 50 (*default = 1*)

F1.2

F1.2.1 - **Calibration unit**
1 - kg (*default*)
2 – lb
3 – g
4 – oz

F1.2.2 - **Gravity value**
9.70000 – 9.99999 (*default = 9.79455*)

F1.2.3 - Calibration of scale

When it displays **E_SCL**, please keep the platform empty and then press **TARE** key to confirm and wait the progress bar [*********] ends.

Then it displays [**LinE2**] for selecting of direct calibration or linearity calibration:

LinE2 = direct calibration

LinE3 = linearity calibration

for **LinE2**, press **TARE** to confirm, and it will display **LoAd**, put the weight on the platform and press **TARE** key to confirm, and input the weight value (60%-100%F.S. suggested) and then press **TARE** key to enter and wait the progress bar [*********] ends, and it will display **End** which means calibration accepted.

for **LinE3**, press **F2** to shift it from **LinE2** to **LinE3** and press **TARE** to confirm, and it will display **LoAd1**, put the middle weight on the platform and press **TARE** key to confirm, and input the weight value (50%F.S. or 50% of the full weight to be used) and then press **TARE** key to enter and wait the progress bar [*********] ends, then it will display **LoAd**, put the full weight on the platform and press **TARE** to confirm, then input the weight value, press **TARE** key to enter and wait the progress bar [*********] ends, it will display **End** which means calibration accepted.

F1.3

F1.3.1 -Auto Zero Track

OFF, 0.5d (*default*), 1d, 3d for selecting.

On OIML mode, 1d and 3d unavailable

On NTEP mode, OFF unavailable

F1.3.2 -Initial Zero Track

OFF, 2%, 10% (*default*), 20% for selecting.

On OIML & NTEP mode, 20% unavailable

F1.3.3 -Zero Track by key operation

OFF, 2% (*default*), 10%, 20% for selecting.

On OIML & NTEP mode, 10% and 20% are unavailable

F1.4

F1.4.1 -Digital Filter

1 - 9 (*default = 5*) for selecting.

The bigger, the more stable, the smaller, the faster. Select it according to the working place where the scale put on.

F1.4.2 -Stable Range

0.5d (*default*), 1d, 3d for selecting.

On OIML & NTEP mode, only 0.5d available.

F1.4.3 -Overloading Range

9d (*default*), 5%, 10%, 20% for selecting.

On NTEP mode, there is no this parameter, as the positive overloading is fixed of 100%F.S.+9d and minus overloading is fixed of -5d

F2

F1.4.1 -Digital Filter

9d (*default*), 5%, 10%, 20% for selecting.

On NTEP mode, there is no this parameter, as the positive overloading is fixed of 100%F.S.+9d and minus overloading is fixed of -5d

F2 – User Functions Setting

F2.1 -	F1 Setting (User Function 1)
<i>None</i>	= none
<i>HoLd</i>	= Hold function
<i>Count</i>	= Counting function
<i>Ti-da</i>	= Time and Date
<i>PHoLd</i>	= Peak hold function
<i>CHEC</i>	= Checkweigh function
<i>Act</i>	= Live Weight Function
<i>ACCU</i>	= Accumulating function
<i>UNIT</i>	= Unit Exchange
<i>_10</i>	= Resolution by 10 times

F2.2 - F2 Setting (User Function 2)
None = none
HoLd = Hold function
Count = Counting function
Ti-da = Time and Date
PHoLd = Peak hold function
CHEC = Checkweigh function
Act = Live Weight Function
ACCU = Accumulating function
UNIT = Unit Exchange
_10 = Resolution by 10 times

F2.3 - Function Setting for IN interface
1 = Zero
2 = Tare
3 = Print
4 = F1
5 = F2

F2.4 - Target Weight
0 – F.S. (default = 1.000)

F2.5 - Positive Tolerance
0 – F.S. (default = 0.010)

F2.6 - Negative Tolerance
0 – F.S. (default = 0.010)

F2.7 - Empty Scale Range
0 – F.S. (default = 0.010)

If the $F2.7 = 0$, then:

UNDER: weight on the scale $< F2.4 - F2.5$, OUT1 active
PASS: $F2.4 - F2.5 \leq$ weight on the scale $\leq F2.4 + F2.5$, OUT2 active
OVER: weight on the scale $> F2.4 + F2.5$, OUT3 active

If the $F2.7 > 0$, then:

weight on the scale $\leq F2.7$, all OUT1, OUT2, OUT3 inactive.
UNDER: $F2.7 <$ weight on the scale $< F2.4 - F2.5$, OUT1 active
PASS: $F2.4 - F2.5 \leq$ weight on the scale $\leq F2.4 + F2.5$, OUT2 active
OVER: weight on the scale $> F2.4 + F2.5$, OUT3 active

F2.8 - UNDER backlight selecting (it must be different from F3.3)
OFF - no backlight for UNDER
RGB - white
R - red
G - green
B - Blue
RG - yellow
RB - magenta
GB - cyan

- F2.9 - OVER backlight selecting** *(it must be different from F3.3)*
OFF - no backlight for UNDER
RGB - white
R - red
G - green
B - Blue
RG - yellow
RB - magenta
GB - cyan
- F2.10 - Beeper for OVER/UNDER check**
OFF - no beeping
ON - beeping
- F2.11 - HoLD, PHold threshold value for unlocking**
0 - manual unlock
xxxxxx - unlock automatically when the weight less than this value, also it can be unlocked manually.
- F2.12 - Animal Weighing Mode**
NANUAL - manual mode
AUTO - auto mode
- F2.13 - Accumulating Weigh Mode**
NANUAL - manual accumulate
AUTO - auto accumulate
- F2.14 - Auto Tare Function**
ON - auto tare
OFF - no auto tare
- F2.15 - Auto Tare Threshold**
0 – F.S. Default of 0.200
- F2.16 - Auto Tare-Clean Threshold**
0 – F.S. Default of 0.100
Note: this value must be smaller than F2.15

F3 – Display Parameters

- F3.1 - Backlight Time**
0 – 10 0 = Backlight always ON
1-10 = 1 minute to 10 minutes *(default of 2min)*

- F3.2 - **Auto Power Off**
0 – 10 0 = No auto power off
 1-10 = 1 minute to 10 minutes (*default of 5min*)
- F3.3 - **Backlight Color**
OFF - no backlight
RGB - white
R - red
G - green
B - Blue
RG - yellow
RB - magenta
GB - cyan
- F3.4 - **Date Setting**
The format is Y: D: T, example of 17:05:01 = 1st, May, 2017
- F3.5 - **Time Setting**
The format is H: M: S, example of 18:25:10 = 18:25:10

F4 – COM Parameters Setting

F4.1 - COM1

F4.1.1 -Protocol Selection for COM1

- 1 = SM Continuous Output Format
- 2 = CA Continuous Output Format
- 3 = MT Continuous Output Format
- 4 = AN Continuous Output Format
- 5 = Demand Output (*format = 4*)
- 6 = MODBUS RTU
- 7 = Key Print Output
- 8 = Stable Output (*format = 4*)
- 9 = Stable Print Output (*G.W., Tare, N.W.,*)

F4.1.2 -Baud Rate for COM1

1200, 2400, 4800, 9600 (default), 19200, 38400, 76800, 115200.

F4.1.3 -Data/Parity Bit for COM1

- 8_N_1 Default, 8 digits, no parity
- 8_E_1 8 digits, even check
- 8_O_1 8 digits, odd check
- 7_E_1 7 digits, even check
- 7_O_1 7 digits, odd check

F4.2 - COM2

F4.2.1 -Protocol Selection for COM2

1 =	SM Continuous Output Format
2 =	CA Continuous Output Format
3 =	MT Continuous Output Format
4 =	AN Continuous Output Format
5 =	Demand Output (<i>format = 4</i>)
6 =	MODBUS RTU
7 =	Key Print Output
8 =	Stable Output (<i>format = 4</i>)
9 =	Bluetooth Output (<i>format =4, baud rate=115200</i>)
10 =	Stable Print Output (<i>G.W., Tare, N.W.</i>)

F4.2.2 -Baud Rate for COM2

1200, 2400, 4800, 9600 (default), 19200, 38400, 76800, 115200.

F4.2.3 -Data/Parity Bit for COM2

8_N_1	Default, 8 digits, no parity
8_E_1	8 digits, even check
8_O_1	8 digits, odd check
7_E_1	7 digits, even check
7_O_1	7 digits, odd check

F4.3 - Communication Node Setting

F4.3.1 -MODBUS RTU Node Address

1-99 Default = 1

F4.3.2 -Bluetooth Node Set (*password fixed, available when F4.2.1=9*)

6 digits Default = Y190_1

F4.4 - Printing Configuration (*the setting of printer must be the same as the terminal's*)

F4.4.1 -Language selecting

EN	English (<i>default, support of EPSON* M188D, Moorange P&T series, etc.</i>)
CH	Chinese (<i>Support of Moorange P&T series, etc.</i>)

F4.4.2 -Date Format (*function for EN only*)

1	Day-Month-Year
2	Month-Day-Year
3	Year-Month-Day (<i>default</i>)

F4.4.3 -Printing Format (*function for EN only*)

1	Single bill
2	Flow bill

F4.4.4 - New Line Enter Sign

0-9

Default = 3

F5 – Maintenance

F5.1 - Reset to Factory Set

YES Reset

No Quit

On OIML and NTEP mode, Geo factor will not reset to default value

F5.2 - Keypad Test

The terminal displays **PrESS**, press the keys from left to right, it will display **ON/OFF**, **ZERO**, **TARE**, **UNIT**, **FUNC**, for the last key, it will display **PRINT** for 1second and then quit.

F5.3 - Display Test

The terminal will display all contents on LCD, check clearly whether some parts missed.

F5.4 - IN interface Test

Active, it will display **IN OFF**

Inactive, it will display **IN ON**

F5.5 - OUT interface Test

The output active one by one, it will display **OUT1**, **OUT2**, **OUT3** and the corresponding lights will be on.

F5.6 - Key Lockout

F5.6.1 **All** ON or OFF (*all locked except for power key*)

F5.6.2 **Zero** ON or OFF

F5.6.3 **Tare** ON or OFF

F5.6.4 **F1** ON or OFF

F5.6.5 **F2** ON or OFF

F5.6.6 **Print** ON or OFF

ON = Active OFF = Lock, inactive

F5.7 - Power Source

0 DC 9-24V or DC adaptor or AC Adaptor

1 DC Adaptor + Li-ion Battery or AC/DC + DC/DC + Li-ion Battery

2 AC/DC Adaptor + Lead-acid Battery

Li-ion battery is 7.4V

Lead-acid battery is 6V

8. MODBUS Output Format

K9 indicator support MODBUS master-slave network communication protocol, has a wealth of switching capabilities, the module, as the slave station, can bi-directionally communicate with the host computer.

The following table is K9 address mapping list in MODBUS:











Mapping Address	Description and Remarks (read only)	
40001	Current weight display, with floating-point symbol	
40002		
40003	Display resolution (-32767...+32767) Note: weight value = resolution (40003) x division (F1.1.4)	
40004	Bit0	1 = Net Weight, 0 = Gross Weight
	Bit1	1 = Dynamic, 0 = Stable
	Bit2	1 = Overload, 0 = Non-overload
	Bit3	1 = IN active
	Bit4	1 = OUT1 active
	Bit5	1 = OUT2 active
	Bit6	1 = OUT3 active
40005	Reserve	

Mapping Address	Description and Remarks (read & write)
40006	Approval: 1 (default) - Non-approval 2 - OIML 3 - NTEP
40007	Max. Capacity, range: 1...65535
40008	Decimal point (0, 1, 2, 3, 4)
40009	Division (1, 2, 5, 10, 20, 50)
40010	Auto Zero Track Range: 1: OFF, 2:0.5d, 3:1d, 4:3d <i>On OIML mode, 1d and 3d unavailable</i> <i>On NTEP mode, OFF unavailable</i>
40011	Initial Zero Track: OFF, 2%, 10%, 20% <i>On OIML & NTEP mode, 20% unavailable</i>
40012	Zero Track by key operation: OFF, 2%, 10%, 20% <i>On OIML & NTEP mode, 10% and 20% are unavailable</i>
40013	Digital filter: 1-9 (default=5)
40014	Stable range: 1:0.5d(default), 2:1d, 3:3d: <i>On OIML & NTEP mode, only 0.5d available</i>
40015	Overload display: 1:9d (default), 2:5%, 3:10%, 4:20% <i>On NTEP mode, the positive overloading is fixed of 100%F.S.+9d and minus overloading is fixed of -5d</i>

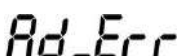
40016	Function Set																		
	<table border="1"> <thead> <tr> <th>F2 (bit15~bit8)</th> <th>F1 (bit7~bit0)</th> </tr> </thead> <tbody> <tr> <td>0 = NONE</td> <td>0 = NONE</td> </tr> <tr> <td>1 = Hold Function</td> <td>1 = Hold Function</td> </tr> <tr> <td>2 = Count Function</td> <td>2 = Count Function</td> </tr> <tr> <td>3 = Time and Date</td> <td>3 = Time and Date</td> </tr> <tr> <td>4 = Peak Hold Function</td> <td>4 = Peak Hold Function</td> </tr> <tr> <td>5 = Checkweigh Function</td> <td>5 = Checkweigh Function</td> </tr> <tr> <td>6 = Live Weight Function</td> <td>6 = Live Weight Function</td> </tr> <tr> <td>7 = Weight Accumulation Function</td> <td>7 = Weight Accumulation Function</td> </tr> </tbody> </table>	F2 (bit15~bit8)	F1 (bit7~bit0)	0 = NONE	0 = NONE	1 = Hold Function	1 = Hold Function	2 = Count Function	2 = Count Function	3 = Time and Date	3 = Time and Date	4 = Peak Hold Function	4 = Peak Hold Function	5 = Checkweigh Function	5 = Checkweigh Function	6 = Live Weight Function	6 = Live Weight Function	7 = Weight Accumulation Function	7 = Weight Accumulation Function
	F2 (bit15~bit8)	F1 (bit7~bit0)																	
	0 = NONE	0 = NONE																	
	1 = Hold Function	1 = Hold Function																	
	2 = Count Function	2 = Count Function																	
	3 = Time and Date	3 = Time and Date																	
	4 = Peak Hold Function	4 = Peak Hold Function																	
	5 = Checkweigh Function	5 = Checkweigh Function																	
6 = Live Weight Function	6 = Live Weight Function																		
7 = Weight Accumulation Function	7 = Weight Accumulation Function																		
40017	Input function: 1: Zero, 2: Tare, 3: Print.																		
40018	Target weight: 0-F.S. (Max:65535)																		
40019	Positive tolerance: 0-F.S. (default=0.010)																		
40020	Negative tolerance: 0-F.S. (default=0.010)																		
40021	OVER backlight selection: 0: OFF - no backlight 1: RGB - white 2: R – red 3: G - green 4: B – Blue 5: RG - yellow 6: RB – magenta 7: GB - cyan																		
40022	UNDER backlight selection: 0: OFF - no backlight 1: RGB - white 2: R – red 3: G - green 4: B – Blue 5: RG - yellow 6: RB – magenta 7: GB - cyan																		
40023	Backlight Time 0 – 10min (default of 2min), 0 = Backlight always ON																		
40024	Auto Power Off 0 – 10min (default of 5min), 0 = No auto power off																		
40025	Backlight selection: 0: OFF - no backlight 1: RGB - white 2: R – red 3: G - green 4: B – Blue 5: RG - yellow 6: RB – magenta 7: GB - cyan																		
40026	Printing Language 1: EN (default) – Printing in English (default, support of EPSON* M188D, Moorange P&T series, etc.) 2: CH – Chinese (support of Moorange P&T series, etc.)																		
40027	Date Format (function for EN only) 1 - Day-Month-Year 2 - Month-Day-Year 3 - Year-Month-Day (default)																		
40028	Printing Format 1 – single bill 2 – Flow bill																		
40029	New Line Enter Sign 0-9 (default =3)																		
40069	Calibration Data Retrieve (Available only after one calibration done). 1: Zero calibration accept. 2: Load weight calibration accept. 3: Input weight too small while loading the weight. 4: Input weight too big while loading the weight. 5: Load weight too small.																		

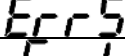
Mapping Address		Description and Remarks (read & write)
40070		Communicating calibration, the input weight set to be WT (no decimal point).
		If WT=0, it's zero calibration (keep the platform empty before zero calibration) If Capacity x 1% ≤ WT ≤ Capacity, it's the load weight calibration point, WT is the value of the weight. To read 40069 for checking the calibration accept or not.
40071	Bit0	1 = ZERO
	Bit1	1 = TARE
	Bit2	1 = TARE Remove
	Bit3	1 = Reset to factory set

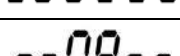
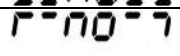
9. Indication & Remarks

Indication	Remark	Possible Solution
	Overload	Remove the weight from the platform
	Minus overload	Check the platform cover put on or not Check the load cell cable connection Check the load cell quality
	Initial weight too big, can't zero	Remove the weight on the platform, then power on again.
	Initial weight too small, can't zero	Put back the platform cover Check the load cell cable connection Check the load cell quality
	EPROM data check error	Reset to factory set Update the software Replace the mainboard
	ADC Initialization error	Reset to factory set Update the software Replace the mainboard
	Keep the platform empty	Remove the weight from the platform
	Loading the weight	
	Loading weight too small	Add more weight
	End of calibration	
	The scale unstable	
	Operation prohibited	
	Exceed the max. zero range	
	Exceed the min. zero range	

10. Main Functions

FN = F1 or F1 key, also it's set with the following functions (refer to F2.1 and F2.2)

- 1 - **Weight Hold**
Press **FN** key to hold the weight, and press **FN** key again to unlock the weight and back to normal weighing mode

- 2 - **Counting**
 Press **FN** key to enter counting mode, it will display the quantity instead of weight. Press **FN** key again to quit counting and back to weighing mode
- Sampling Methods:**
 On counting mode, keep pressing **TARE** key to enter sampling menu,
 for **AUTO** mode, just put the samples and input the quantity.
 for **INPUT** mode, input the sample weight and the sample quantity
(weight and quantity must > 0)
(F1 and F2 to move and change the digits and TARE to confirm)
- 3 - **Date/Time**
 Press **FN** key to display the date and press **FN** key again to display the time. Press **FN** key again to quit and back to weighing mode
- 4 - **Peak Hold**
 Press **FN** key, the terminal will start to record the peak value of the weight, press **FN** key again to quit and back to weighing mode
- 5 - **Checkweigh**
 Press **FN** key, the terminal will start to check and grade the weight, press **FN** key again to quit and back to weighing mode
 If the F2.7 (empty scale range) = 0, then:
UNDER: weight on the scale < F2.4-F2.5, OUT1 active
PASS: F2.4-F2.5 ≤ weight on the scale ≤ F2.4+F2.5, OUT2 active
OVER: weight on the scale > F2.4+F2.5, OUT3 active
 If the F2.7 (empty scale range) > 0, then:
 If weight on the scale ≤ F2.7, all OUT1, OUT2, OUT3 inactive.
UNDER: F2.7 < weight on the scale < F2.4-F2.5, OUT1 active
PASS: F2.4-F2.5 ≤ weight on the scale ≤ F2.4+F2.5, OUT2 active
OVER: weight on the scale > F2.4+F2.5, OUT3 active
- 6 - **Live weight**
 Press **FN** key, the terminal will act the animal weighing, and the display will lock the average weight after the progress bar ends. press **FN** key again to quit and back to weighing mode
- 7 - **Accumulation**
 Press **FN** key, the terminal will accumulate the current weight to the total weight and display the total weigh, press **PRINT** key to print the total weight. press **FN** key again to quit and back to weighing mode
*During the total weight display, press **ZERO** key to clean it.*
- 8 - **UNIT Exchange**
 Press **FN** key to exchange the weight unit to the 2nd unit, and press **FN** key again to back to the 1st unit *(calibration unit taken as the 1st unit).*

- 9 - **x10 Resolution**
 Press **FN** key to enlarge the resolution by 10 times, press **FN** key again to quit and back to normal weighing mode.

11. Communication Protocols

11.1 SM Continuous Output Format

<lf> <s> <r> <n> <m> <f> <xxxxxx.xxx> <uuu> <cr>

Where:

lf = Line Feed (hex 0A)

s = Flags Z = center of Zero,

O = Overload,

E = zero Error

e = weight not currently being displayed

r = Range 1

n = Mode G = Gross, T = Tare, N = Net

m = Motion M = Motion, " "(blank) = no motion

f = Sign "-" = negative, " " (blank) = positive

xxxxxx.xxx = Weight Ten characters including decimal point (if any)

uuu = Units lb, oz, kg, g

cr = Carriage Return(hex 0D)

11.2 CA Continuous Output Format

<s> <xxxxxx> <d> <uu> <m> <cc> <cr>

Where:

s = Sign "-" = negative, " " (blank) = positive

xxxxxx = Weight Six digits

d = Decimal point Added to string if enabled in setup

uu = Units LB, OZ, KG, G

m = Mode G = Gross, N = Net

cc = Weight Status OC = overload CZ = center of zero MO = motion

EE = weight not currently being displayed

cr = Carriage Return (hex 0D)

11.3 MT Continuous Output Format

STX	SWA	SWB	SWC	X	X	X	X	X	X	X	X	X	X	X	X	CR	CKS
1	2			3				4				5	6				

1. <STX> ASCII Start Sign (02H)
2. Status A, B, C

3. Weight value, could be gross weight or net weight, 6 digits, no sign and decimal point.
4. Tare value, 6 digits, no sign and decimal point.
5. <CR> ASCII return sign (ODH)
6. <CKS> Checksum

Status number : A , B , C

A			
Bits 0 , 1 , 2			
0	1	2	Decimal point
1	0	0	XXXXX0
0	1	0	XXXXXX
1	1	0	XXXXX.X
0	0	1	XXXX.XX
1	0	1	XXX.XXX
Bit 3			always 0
Bit 4			always 0
Bit 5			always 1
Bit 6			always 1
B			
Bits	Function		
Bit 0	Gross weight = 0 , Net weight = 1		
Bit 1	Sign : Positive = 0 , Negative = 1		
Bit 2	Overload (or <0) = 1		
Bit 3	Dynamic = 1		
Bit 4	Unit : lb = 0 , kg = 1		
Bit 5	Always = 1		
Bit 6	Always = 0		

C	
Bits	Function
Bit 0	Always = 0
Bit 1	Always = 0
Bit 2	Always = 0
Bit 3	Always = 0
Bit 4	Always = 1
Bit 5	Always = 1
Bit 6	Always = 1

11.4 AN Continuous Output Format

ST, +00000.00_kg CR LF

Four types of headers are available:

ST : Stable weight data

US : Unstable weight data (including counting data)

QT : Stable counting data

OL : Out of weighing range

The data is always 9 digits including a sign and a decimal point.

Four units are available:

_kg : Weight data in "kilograms" (kg) _lb : Weight data in "decimal pounds" (lb)

_PC : Counting data in "pieces" (pcs) _oz : Weight data in "decimal ounces" (oz)

The terminator is always CR LF.

Example of output data:

Weight data "kg" ST, +00123.45_kg CR LF

Counting data "pcs" QT, +00012345_P C CR LF

Out of weighing range "kg" (+) OL, +99999.99_kg CR LF

Out of weighing range "pcs" (-) OL, -99999999_P C CR LF

11.5 Demand Output

ENQ - (hex 05) Format = AN Continuous format

11.6 Printing Format

F4.4.3 = 1: Standard weighing

```

WEIGHING REPORT
17/05/2017 10:21:18
-----
Gross 100.1kg
Tare 20.1kg
Net 80.0kg
    
```

Accumulated Report

```

WEIGHING REPORT
17/05/2017 10:21:18
-----
Gross 100.1kg
or Net 80.0kg
Total 500.0kg
    
```

Counting mode

```

WEIGHING REPORT
17/05/2017 10:21:18
-----
Gross: 100.0kg
(or Net 100.0kg)
Single: 1.0kg
Quantity: 100
    
```

Checkweigh Mode

```

WEIGHING REPORT
17/05/2017 10:21:18
-----
Gross 100.0kg
or Net 100.0kg
Status OK
or OVER or LOW
    
```

F4.4.3 = 2: Flow Weighing Bill

WEIGHING REPORT
17/05/2017 10:21:18

No.0001: 100.1kg G
No.0002: 100.1kg N
No.0003: 100.1kg N
.....
No.0100: 100.1kg G

VALUE EACH GRAM
HiWEIGH