



PHYSICIAN SCALE HH

User Manual

VALUE EACH GRAM
HiWEIGH

The applicable objects:

Anyone to install, debug or diagnose the Y180 Weighing Control Module. You should have basic knowledge of circuit and weighing. If not, then some training is advised before using the product.

The content of the manual:

This manual is the instruction of Y180 Weighing Control Module. It introduces the installation, connection and trouble diagnosis of the controller. This manual:

Explains how to install and connect the modules;

Introduces the overview of Y180 Weighing Control Module.



Cautions: *Only professionals can debug, examine and repair the system.*



Cautions: *Hot-line work is forbidden. Make sure the power has been cut before electrical work.*



Cautions: *This module is electrostatic-sensitive device. Take anti-static measures during the use and maintenance.*

Contents

Chapter 1 Introduction	1
1.1 Overview	1
1.1.1 Performance	1
1.2 Specifications	1
1.3 Dimensions	2
1.4 Scale Base	2
1.5 Display and Keypad	3
Chapter 2 Installation	4
2.1 Module Installation	4
2.2 Wire Connection	5
2.1.1 Power Supply Connection	6
2.1.2 Load Cell Connection	6
2.1.3 Serial Port Connection	7
2.1.5 DA Connection	8
Chapter 3 Operation	9
3.1 Display Screen	9
3.2 Keypad Operation	9
3.3 Operation Menu	10
Chapter 4 Parameter Configuration	11
Appendix A Menu	15
A Menu Tree	15
Appendix B Data Format	16
B.1 Serial Interface Parameters	16
B.2 Continuous Output Format	16
B.3 MODBUS Output Format	16
Appendix C Prompts	19
Appendix D Software Update	20
D.1 Software Update	20
D.2 Wire Connection	20
D.3 Update Steps	20

Chapter 1 Introduction

Y180 is the weighing control module used in process weighing and it has powerful functions, friendly display interface, abundant information, easy operation and stable performance.

This chapter covers

- Overview
- Type
- Specifications
- Construction and Dimensions
- Scale Base
- Display and keypad

1.1 Overview

1.1.1 Performance

- Modular design, guide rail type installation
- Supports one analog scale base (up to six 350Ω load cell)
- 6 digits LED Segment Displays for clear readability in varying light conditions.
- 24VDC power supply input
- Zeroing, Taring, Clearing functions are accessible on the keypad.

1.2 Specifications

Table 1-1 module specifications

Specifications	
Housing	Plastic, with display and operation panel.
Dimensions (w*h*d)	86.8mm×57.9mm×71.5mm
Safety	IP20
Working conditions	Temperature: $-10^{\circ} \sim 40^{\circ}\text{C}$ ($14^{\circ} \sim 104^{\circ}\text{F}$) Relative humidity: 10% \sim 95%, no condensation
Power Supply	+24VDC ($\pm 10\%$), power < 3W
Display Screen:	6 digits green LED Segment Displays, with the height of 0.32 ”
Weight value display	Maximum displayed division: 100,000

Scale base type	• One analog scale base
Load cell quantity	1-6 350Ω load cells (with the sensitivity of 2 or 3mV/V)
A/D update rate	A/D conversion rate 200 Hz
Load cell excitation voltage	5VDC
Minimum input sensitivity	0.6μV/d
Keypad	4 membrane keys
Communication	<p>Serial port:</p> <p>One RS-232, 4800~115,200 baud rate</p> <p>One RS-485, 4800~115,200 baud rate</p> <p>Supported protocol:</p> <p>Continuous output, MODBUS-RTU</p> <p>Analog output port:</p> <p>0~5V, 0~10V, -5V~+5V, -10V~+10V,</p> <p>0~20mA, 4~20mA, 0~24mA</p>

1.3 Construction and Dimensions

The following figures introduce the construction and dimensions of Y180 in mm.

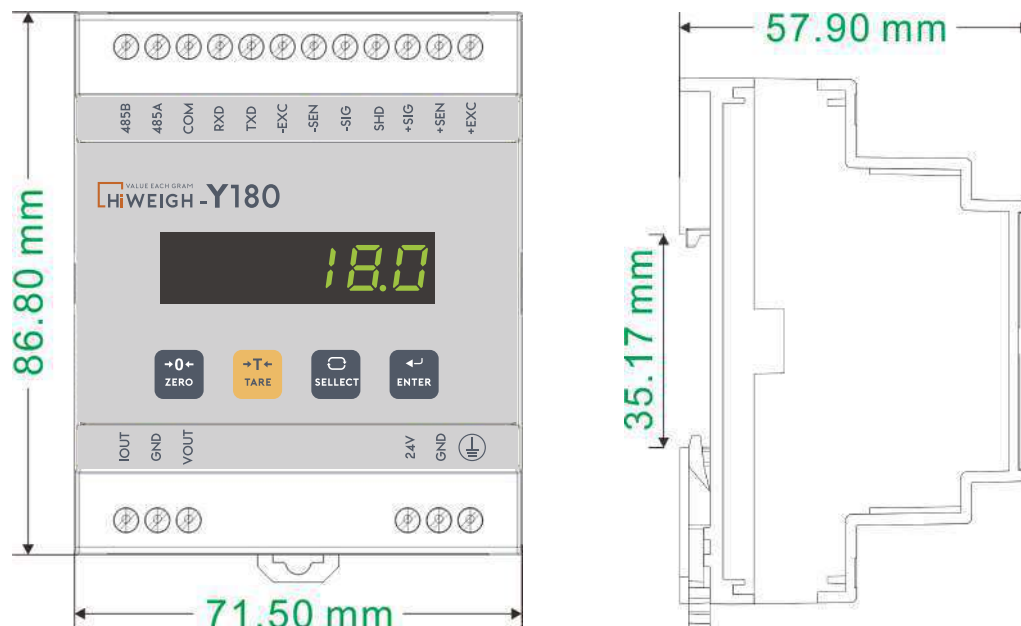

1.4 Scale Base

Y180 module supports analog scale base. It provides 5 V excitation voltage to drive six 350Ω

analog load cells.

6-wire load cell ensures the accurate weighing even if the resistor of the load cell wires increases along with temperature.

1.5 Display and keypad

Y180 module display consists of 6 0.32" green LED segment displays. See the following figure.



The 4 keys on the front side of the display have the basic functions of zeroing, taring, selecting and confirming. They can also be used to enter the setting menu, select the options and input values.

Chapter 2 Installation

This chapter introduces the installation of Y180. Please read the chapter carefully before the installation.

This chapter covers

- Installation module
- Wire connection

2.1 Module Installation

Y180 module goes with the standard guide rail type installation and can be installed onto the 35mm wide guide rail. Firstly, confirm that the fixed lock is unlocked.

Fix Y180 on the guide rail according to the direction of the red arrow below. And it is detached in the same way.



2.2 Wire connection

Y180 module pin definition is as follow.

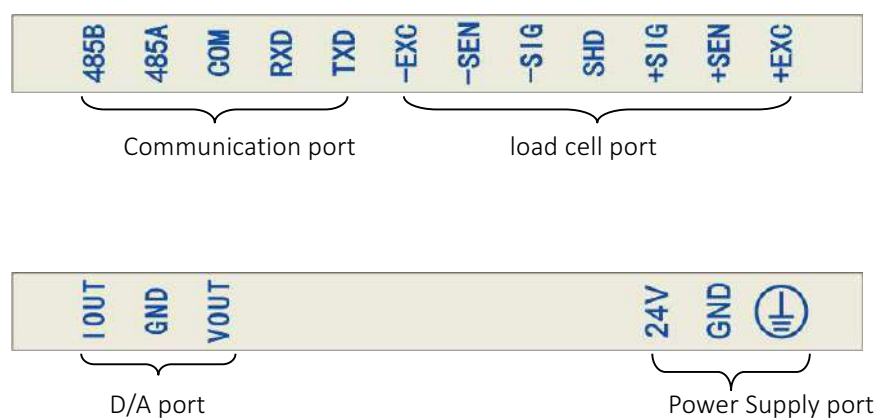

The following is the typical application diagram of Y180 module

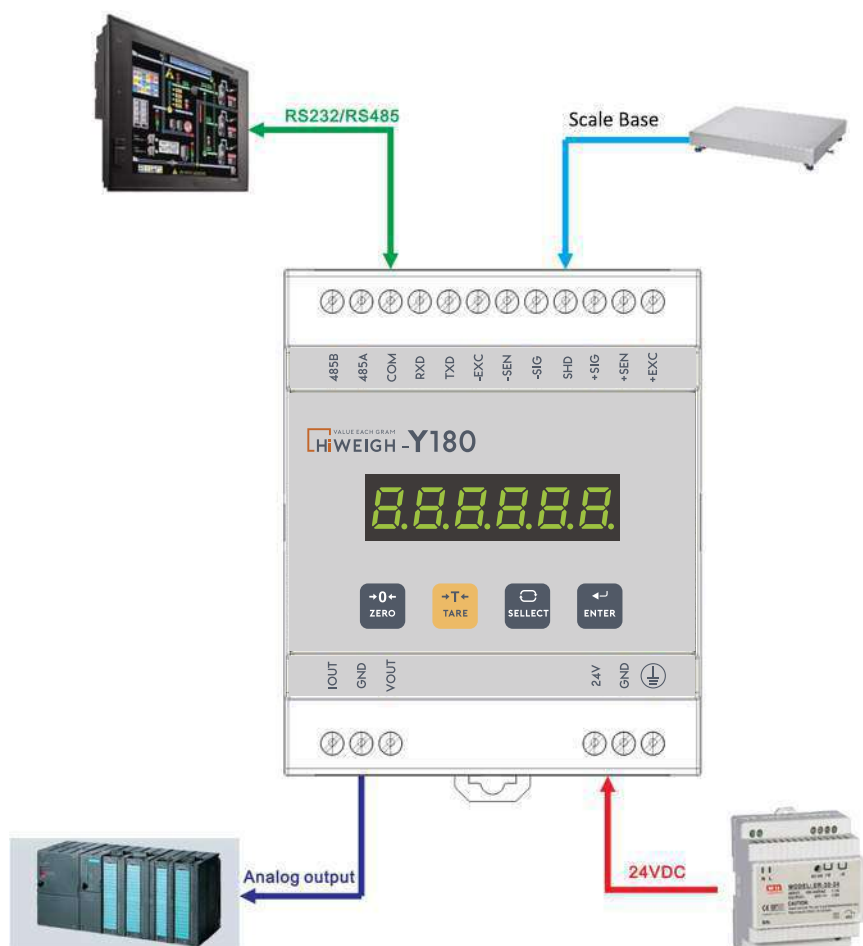

2.1.1. Power Supply Connection

Y180 module is powered by 24V DC. 24V DC power supply must be directly connected to the mainboard terminal.

Pins	Signal	Instructions
24V DC	24V positive external power supply	
GND	24V negative external power supply	
	Ground wire	Connect here if there is protective ground wire in the user's place.

2.1.2. Load Cell Connection

Y180 module can connect 6 350 Ω (or the minimum 58 Ω) analog load cell. Total scale resistance (TSR) of the scale must be calculated to know whether the connected load cell is within the allowed range.

$$\text{TSR} = \frac{\text{Load cell input resistance } (\Omega)}{\text{Load cell quantity}}$$

Before connecting the load cell, make sure that the TSR of load cell network connected to the terminal is above 58 Ω . If lower, the terminal will fail to work normally.

Besides, the maximum wire distance should also be taken into consideration. Table A-2 is the max wire length recommended according to the TSR and the wire specifications.

Table A-2 max wire length recommended

TSR (Ω)	Wire 24 (m)	Wire 20 (m)	Wire 16 (m)
350	243	610	1219
58 (350 Ω *6)	40	122	224

Load cell interface terminals definition:

Pins	Signal	Instructions
+EXC	Positive excitation	Short connected to the 4-wire load cell.
+SEN	Positive sense	
+SIG	Positive	

	Signal	
SHD	Shield ground	
-SIG	Negative Signal	
-SEN	Negative sense	Short connected to the 4-wire load cell.
-EXC	Negative excitation	

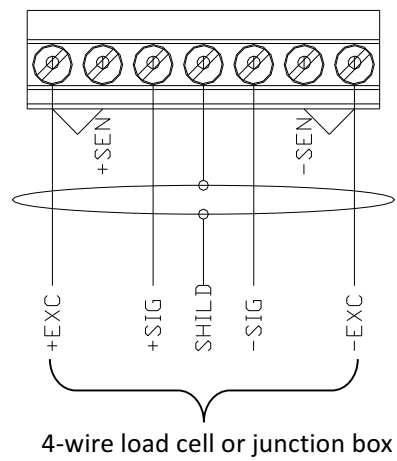
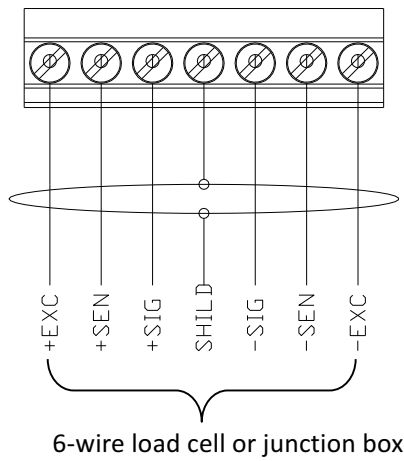

2.1.3 Serial port connection

Y180 module includes 2 independent serial ports, one being RS232 and the other RS485. Pin definition is as follow:

Pins	Signal	Instructions
TXD	RS232 sending	
RXD	RS232 reception	
COM	COM port ground (common ground of RS323 and RS485)	
485A	RS485 positive reception	
485B	RS485 negative reception	

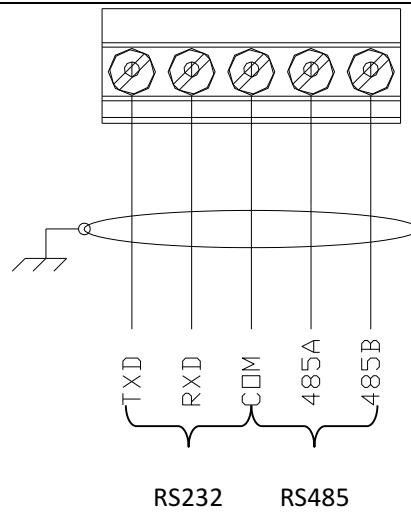

2.1.4 DA Connection

Y180 module provides 0~5V, 0~10V, -5V~+5V, -10V~+10V, 0~20mA, 4~20mA, 0~24mA analog signal, input proportionally to the weight on scale.

Pins	Signal	Instructions
IOUT	Current output	Output resistance 350Ω (max)
GND	Analog output ground	
VOUT	Voltage output	Output resistance 1KΩ (min)

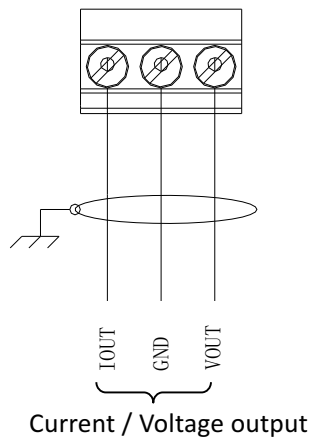

Chapter 3 Operation

This chapter introduces the basic operation and functions of Y180 module.

This chapter covers

- Display Screen operation
- Keypad operation
- Operation menu

3.1 Display Screen

In the weighing mode, display screen is for displaying the weight and other information related to weight with 6 digits 0.32" green LED display.

See the following figure:



Display Screen

After entering the operation menu or setting menu, display screen will display the menu, options and settings.

3.2 Keypad operation





Y180 module can be operated by the front panel keys

See the following figure for the 4 keys on the Y180 front panel. The below table introduces the functions of the 4 keys in the normal operations



Keys of Y180 module

The keys in the main weighing interface are for:





Mark	Definition	Function
	Zero	When Pushbutton Zero function is on in Settings and it is within the range, Pushing the button can capture a new gross weight zero reference point.
	Tare	Tare weight is the weight of the empty container. Gross weight minus tare weight is net weight. Press Tare when the container is empty, it reads the net weight 0. When the container is loaded, it reads the net weight of the contained object. Activate the function of Tare in Settings before using this key.
	Select	No function
	Confirm	Long press this key for 3 seconds at the main weighing interface to enter the Settings page.

When the scale base is in motion, taring and zeroing functions can not be used.

3.3 Operation menu

Long press  for 3 seconds at the weighing interface to enter the Operation menu. The display changes from weighing to Main menu.

After entering the Operation menu, the 4 buttons will do the guiding. The following are the functions of the keys when inputting in the Operation menu.

Mark	Weighing	Selecting	Editing
	Zero the scale	Return / Exit	Return without saving
	Tare / Clear	Page down	Increase
	-	Page up	Move the cursor / Increase
	Long press to enter Settings	Move on to the secondary menu	Return after saving

Chapter 4 Parameters Settings

This chapter introduces the settings and scale calibration of Y180

This chapter covers

- F1 Scale port parameters
- F2 Analog output port parameters
- F3 Communication port parameters
- F4 Maintenance menu

F1 Scale port

Parameter	Option	Instructions
F1.1 Maximum capacity	1≤Capacity≤60000 Default: <u>6</u>	1. Input the maximum capacity value according to the actual need.
F1.2 Decimal place	Range: 0~4 Default: <u>3</u>	
F1.3 Division	1/2/5/10/20/50 Default: <u>1</u>	
F1.4 Zero point calibration	0: Skip 1: Enter	1. "E_SCAL" instructs to remove the loader on the scale. 2. Unload the scale and press ENTER The module starts count down and read the value of empty scale 3. Go to F1.5
F1.5 Load point calibration	0: Skip 1: Enter	1. "LOAD" instructs to load the counterweight. 2. Wait for the scale to be stable. Press "ENTER" to enter the Counterweight Weight interface. 3. Input the weight of the load and press ENTER. Down count the module and read the value. 4. Go to F1.6
F1.6 Filter grade	Range: 0~9 Default: <u>1</u>	1. Press Select to select; press ENTER to confirm. 2. The larger the value, the more wavy the filter.

F1.7 Motion range	OFF: No motion detection 1d: 1d 2d: 2d <u>3d: 3d</u> 4d: 4d 5d: 5d	1. Press "Select" to select 2. Off: No motion detection
F1.8 Overload range	9d: $\pm 9d$ 5: Capacity $\times 5\%$ 10: Capacity $\times 10\%$ <u>20: Capacity$\times 20\%$</u> 100: $\pm(\text{Capacity}+9d)$	
F1.9 Power up zero range	<u>OFF: Power up zero off</u> 5: Capacity $\times 5\%$ 10: Capacity $\times 10\%$ 20: Capacity $\times 20\%$	
F1.10 Pushbutton Zero range	OFF: Pushbutton Zero off 5: Capacity $\times 2\%$ 10: Capacity $\times 10\%$ <u>20: Capacity$\times 20\%$</u>	
F1.11 Zero track Range	OFF: Zero track off 1d: 1d 2d: 2d <u>3d: 3d</u> 4d: 4d 5d: 5d	

F2 Analog output port parameters

Parameter	Option	Instructions
F2.1 Analog mapping object	0: 0 ~ +5V output <u>1: 0 ~ +10V output</u> 2: -5V ~ +5V output 3: -10V ~ +10V output 4: 4mA ~ 20mA output 5: 0mA ~ 20mA output 6: 0mA ~ 24mA output	0: 0~Cap ----- \rightarrow 0 ~ +5V 1: 0~ Cap ----- \rightarrow 0 ~ +10V 2: -Cap~+Cap -- \rightarrow -5V ~ +5V 3: -Cap~+Cap -- \rightarrow -10V ~ +10V 4: 0~Cap ----- \rightarrow 4mA ~ 20mA 5: 0~Cap ----- \rightarrow 0mA ~ 20mA 6: 0~Cap ----- \rightarrow 0mA ~ 24mA

F2.2 Analog Zero Point Calibration	<u>0 ~ 65535</u>	Put the probe of multimeter onto the analog output terminal according to the settings of F2.1 object. Pay attention to the current and voltage and make sure the multimeter is in accordance. Observe whether the readings of multimeter is correct. If not, adjust the value. The larger the value is, the larger the multimeter reads.
F2.3 Analog Full Span Calibration	<u>0 ~ 65535</u>	Analog full span calibration, same as F2.2.

F3 Communication port parameters

Parameter	Option	Instructions
F3.1 Serial Port 1 format	0: No output 1: Toledo continuous output mode <u>2: MODBUS-RTU mode</u>	
F3.2 Serial port 1 digital place F3.3 Serial Port 2 format	<u>0: 8 digits without check</u> 1: 7 digits without check 2: 7 digits even check 3: 8 digits odd check 4: 8 digits even check 0: No output 1: Toledo continuous output mode <u>2: MODBUS-RTU mode</u>	
F3.4 Serial port 2 digital place	<u>0: 8 digits without check</u> 1: 7 digits without check 2: 7 digits even check 3: 8 digits odd check 4: 8 digits even check	

F3.5 Serial port baud rate:	0: 4800 1: 9600 2: 19200 3: 38400 4: 115200	
F3.6 Node Address	Range: 1 ~ 99 Default: <u>01</u>	

F4 Maintenance menu

Parameter	Option	Instructions
F4.1 Load default	<u>0: default without load.</u> 1: default with load.	
F4.2 Display screen check		

Appendix A Menu

This chapter covers

- Tree diagram of the menu

A Tree diagram of the menu

MENU TREE

F1 Scale Parameters	F2 Analog Output Port	F3 Communication Port	F4. Maintenance
F1.1 Capacity	F2.1 Mapping object	F3.1 Com1 Format	F4.1 Reset
F1.2 Decimal Point	F2.2 Analog Zero Calibration	F3.2 Com1 Baud Rate	F4.2 Display Check
F1.3 Division	F2.3 Analog Load Calibration	F3.3 Com2 Format	
F1.4 Zero Calibration		F3.4 Com2 Data Bit	
F1.5 Load Calibration		F3.5 Baud Rate	
F1.6 Filter Class		F3.6 Node Address	
F1.7 Motion Range			
F1.8 Overload Range			
F1.9 Initialization Zero			
F1.10 Manual Zero			
F1.11 Zero Track			

Appendix B Data format

This chapter introduces the communication of Y180.

This chapter covers

- Continuous output format
- MODBUS output format

B.1 Serial interface parameters

Y180 provides 2 standard serial interfaces, one is RS232 interface TXD, RXD and COM also used for downloading new Y180 software, and the other is RS485 interface 485A, 485B and COM.

Y180 provides 2 ways of data output, continuous and MODBUS.

B.2. Continuous Output format

The continuous output template of Y180 can transmit the information of weighing capacity and scale to the remote devices such as PC or display.

Continuous output format																
STX	A	B	C	X	X	X	X	X	X	X	X	X	X	X	X	CR
1	2		3						4				5			

1. <STX>ASCII start character (02H)
2. Status word A, B, C.
3. Displays the weight, gross weight or net weight. 6 digits unsigned figure without decimal.
4. Tare weight, 6 digits unsigned figure without decimal.
5. <CR>ASCII carriage return (0DH).

	Status word A	Status word B	Status word C
Bit0	010: no decimal 011: 1 decimal place	0 = gross weight 1 = net weight	1 = OUT0 effective
Bit1	100: 2 decimal places	1 = weighs below 0	1 = OUT1 effective
Bit2	101: 3 decimal places 110: 4 decimal places	1 = overranged	1 = OUT2 effective
Bit3	Constant 0	0 = static, 1 = in motion	1 = OUT3 effective
Bit4	Constant 0	Unit: 0 = kg, 1 = g	Reserved
Bit5	Constant 1	Constant 1	Constant 1
Bit6	Constant 0	Constant 0	1 = IN0 effective
Bit7	Constant 0	Constant 0	1 = IN1 effective

B.3 MODBUS output format

Mapping Address		Definition and Remarks (read-only)
40001		Weight value currently displayed Signed integer: range from -32767 to 32767 without decimal. Unsigned integer: range from 0 to 65535 without decimal. See 40004 for the sign. For beyond 65535, take the following floating-point number form.
40002		Weight value currently displayed floating-point number form
40003		
40004	Bit0	1 = net weight, 0 = gross weight
	Bit1	1 = negative weight, 0 = positive weight
	Bit2	1 = in motion
	Bit3	1 = overloaded
	Bit4	1 = underloaded
	Bit5	1 = Failed to zero when turned on
Mapping Address		Definition and Remarks (read and write)
40006		Full Span Capacity (1 ~ 60000)
40007		Decimal place (0-4)
40008		Division (1 / 2 / 5 / 10 / 20 / 50)
40009		Filter grade (1-9)
40010		Motion range (0-5)
40011		Overload display range (0-3)
40012		Power up zero range (0-3)
40013		Pushbutton Zero range (0-3)
40014		Zero track range (0-3)
40015		Analog mapping object (0-6)
40016		Calibration information. Clear this information before calibration. Read the information after calibration. 0x01 : Zero point calibrated; 0x02 : Load point calibrated; 0x03 : Input weight too low in load point calibration

	0x04 : Input weight too high in load point calibration 0x05 : Loaded weight too low in load point calibration 0x06 : Scale in motion during calibration
Mapping Address	Definition and Remarks (write-only)
40020	Scale calibration Write 0: Calibration zero point Write XXXXX: Load point calibration $1 \leq \text{XXXXXX} \leq \text{Capacity}$ Calibration information reads 40016.
40021	Write 1: Load default value
40022	Write 1: Zeroing

Appendix C Prompts

This chapter introduces the prompts of Y180.

This chapter covers

- Prompts

No.	Prompts	Definition
1	【R-----】	Overloaded
2	【L-----】	Underloaded
3	【Ad Err】	AD initialization error
4	【EP Err】	EEPROM check error
5	【 _EEE 】	Failed to zero when turned on; underweight
6	【 EEE 】	Failed to zero when turned on; overweight
7	【End 】	Zero point and load point calibrated
8	【Err 03】	Input weight too low in communication load point calibration
9	【Err 05】	Input weight too high in communication load point calibration
10	【Err 06】	Loaded weight too low in communication load point calibration
11	【Err 07】	Scale in motion during calibration
12	【E_SCAL】	Instructs to empty the scale during calibration
13	【LOAD 】	Instructs to load the counterweight during calibration
14	【--NO--】	Invalid operation
15	【Ld--- 】	Loading default

Appendix D Software update

This chapter introduces the software update of Y180.

This chapter covers

- Software update
- Wire connection
- Update steps

D.1 Software update

It's convenient to update software of Y180 module with computer. The edition number changes every time after updating. (The new edition software is without notice.)

Caution: After updating, the system settings may be changed. So please back up the parameters before updating.

D.2 Wire connection

Y180 module is connected to the computer by their serial ports. If the computer has no serial port, use a USB adapter wire.

Serial port connection is as follow:

Controller serial port	Computer serial port	
	9 pins	25 pins
TXD	2	3
RXD	3	2
COM	5	7

D.3 Update steps

This module uses STC-ISP application software to update the Y180 software. This application software can be downloaded at the official site of STC: <http://www.mcu-memory.com>

Update steps:

1. Power off the Y180 module.
2. Open the STC-ISP software.



3. As follow, select the chip type, serial port number and hardware.

You can set as the following:

- ① Single chip type: STC12C5A60S2

- ② Serial port number: Select according to your computer.
- ③ Hardware: as shown in the red box.

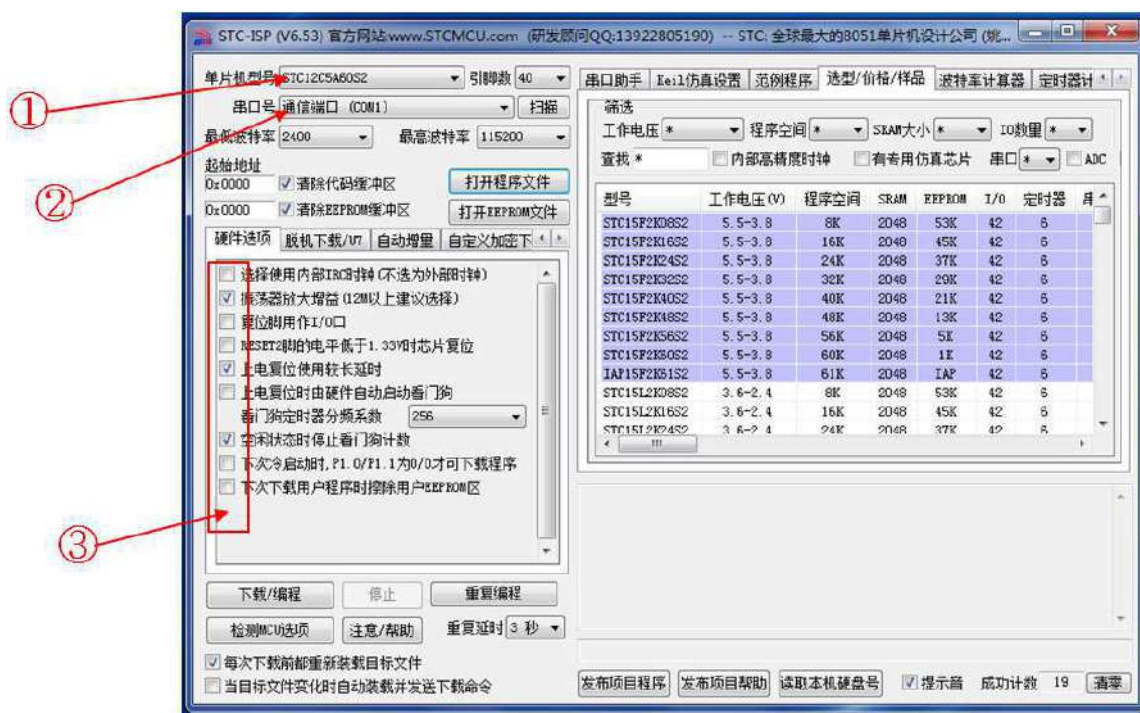

6. Select the HEX file to be burned.

- ④ Open the program file. Open the program file according to the path of the program.



7. Program file loaded as follow:

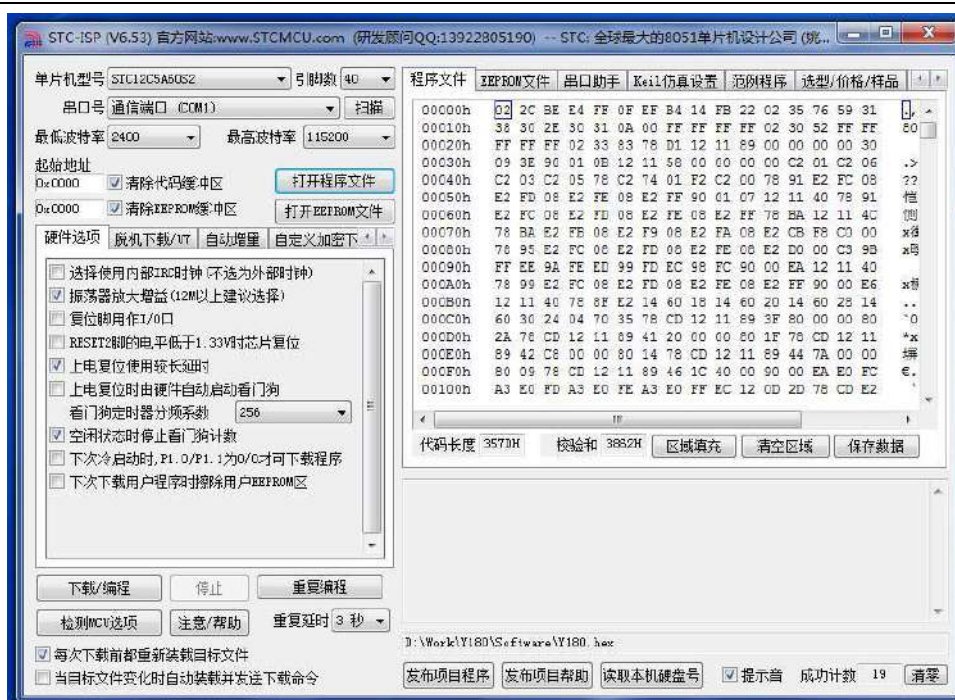

8. Download / programming

⑤ Click Download / programming and start downloading.

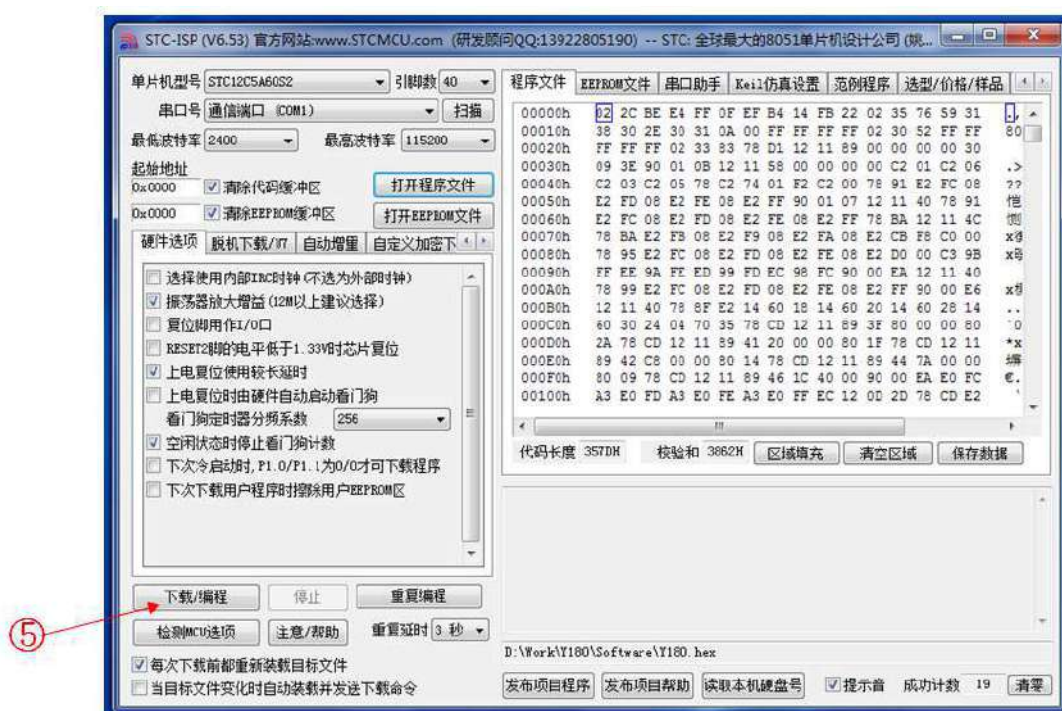

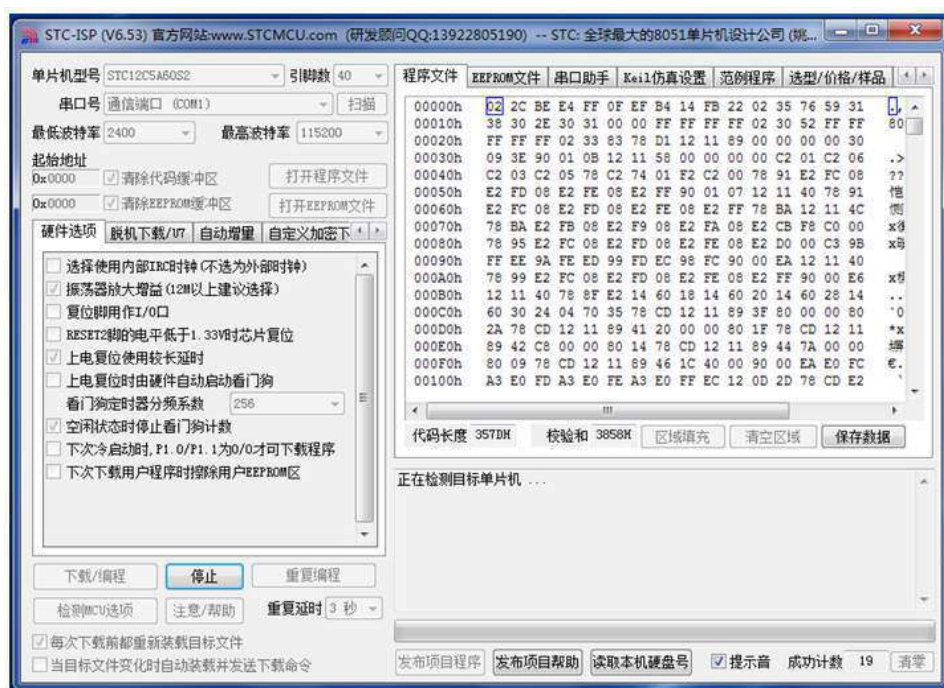

8. Power on Y180 module, start downloading the program. It prompts “Operation succeeded” as follow after it’s done.

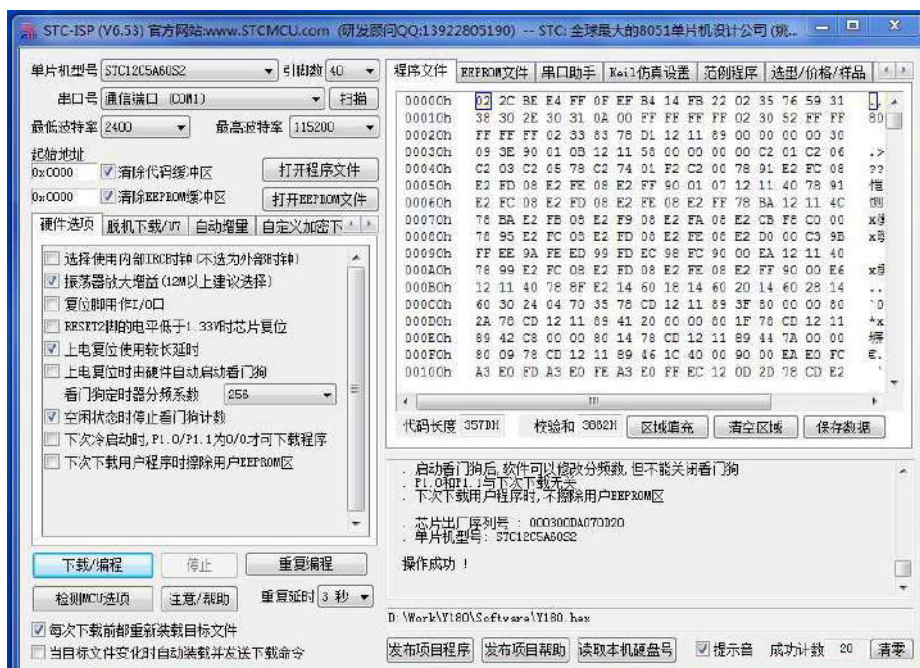

9. The module restarts and the update is done.

VALUE EACH GRAM
HiWEIGH